

# Professionelle Ausgabesysteme

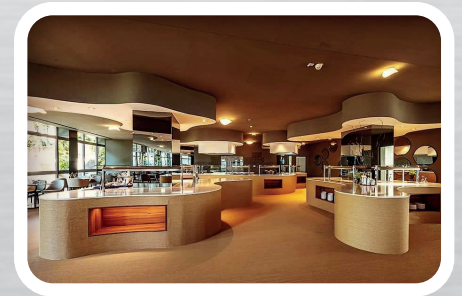

WARMHALTEPLATTEN, BUFFETPLATTEN, TABLE COOKING

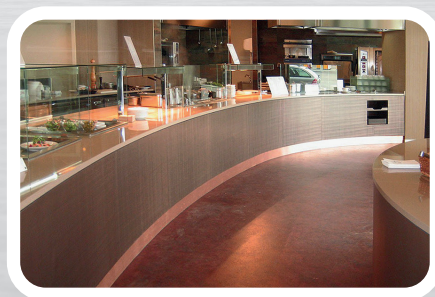
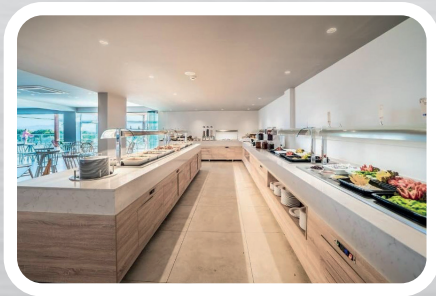

KÜHLUNG, SALADETTEN, GN-NORM, EISBUFFETS



EINRICHTUNG FÜR KASSENSYSTEME

Moderne Ausgabe Systeme, völlig frei konfigurierbar, hochwertige Verarbeitung.  
Denken Sie Speisenausgabe neu!

**HOFFMAN**

made by



# Drop-In Serien

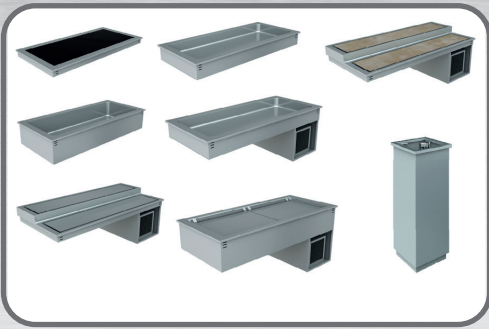

## ARIES

Warmhalteplatten, Kühlplatten, GN-Behälter, Besteckspender. Hochwertiger Edelstahl.

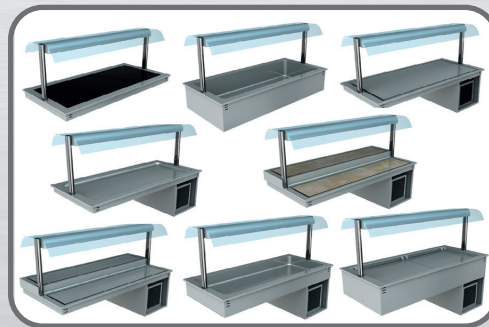

## LIBRA

Warmhalteplatten, Kühlplatten, GN-Behälter. Alle mit Glasabdeckung und Beleuchtung.

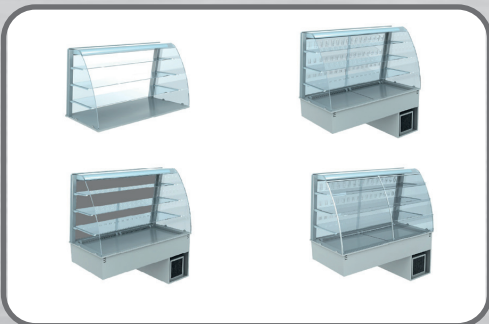

## VIRGO

Kühlgeräte mit gebogener Glasvitrine.

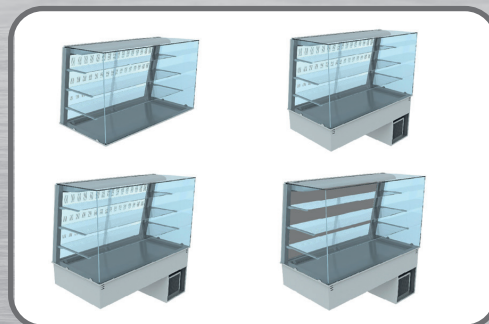

## LYRA

Kühlgeräte mit rechteckiger Glasvitrine.

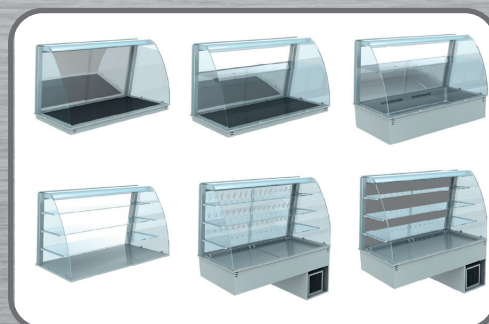

## GEMINI

Kühlgeräte und Warmhalteplatten mit gebogener Glasvitrine.

# Qualität und Individualität



Eine höhere Qualität der Speisen, gesteigerte Flexibilität und die Bereitschaft zur kreativen und improvisierten Gestaltung des Speiseambientes – wer großen Wert auf ein ausgewogenes Verhältnis von Preis und Funktionalität legt, findet in den Ausgabesystemen von Hoffman die ideale Lösung. Die Module, gefertigt aus hochwertigem Edelstahl, lassen sich nach Belieben kombinieren und individualisieren.

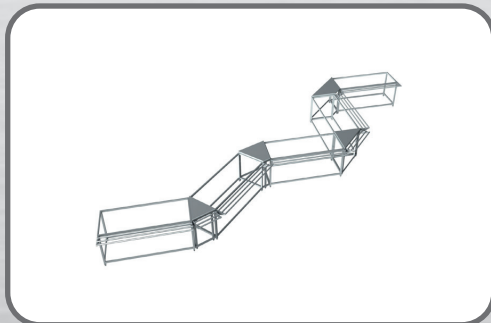

## PLANUNG & AUFBAU

Die Planung und der Aufbau des hochwertigen Edelstahl Grundgerüsts erfolgt ganz nach Ihren individuellen Wünschen und dem Objekt.

## DROP-IN GERÄTE

Nach dem Aufbau des Grundgerüsts erfolgt die Bestückung mit den passenden Drop-In Geräten aus den umfangreichen Serien.

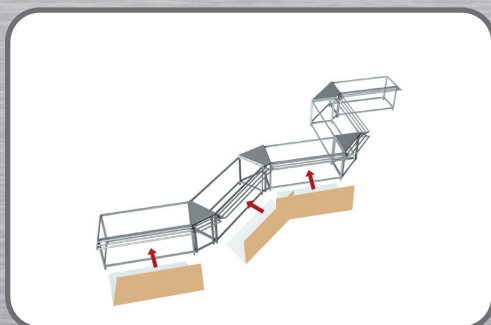
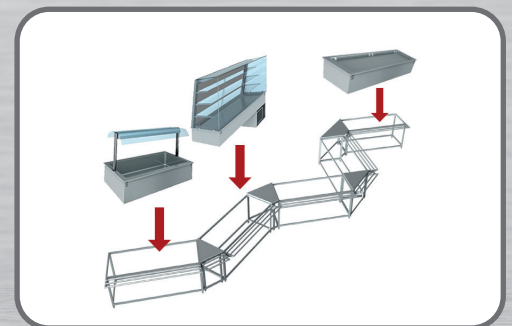







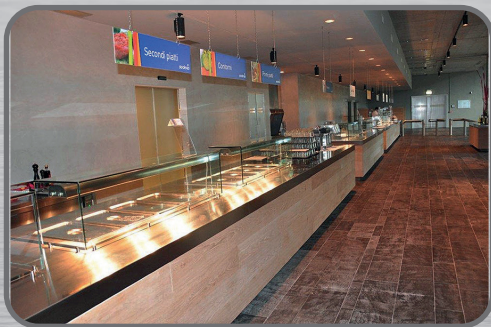
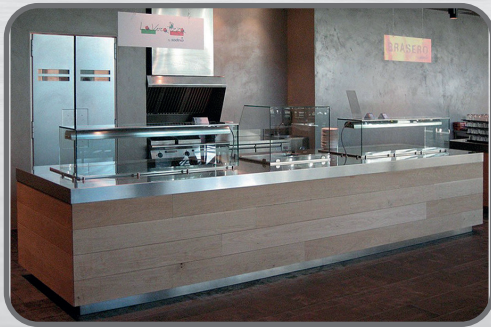









## VERKLEIDUNG









Nach der Installation erfolgt die Verkleidung und die finale Anpassung an das vorgegebene Design. Zur Auswahl stehen alle hochwertigen Materialien wie Granit, Holz, PVC oder Kombinationen. Zum Schluß erfolgt die finale Abnahme nach erfolgreichem Funktionstest.

# Referenzen





PREISLISTE 2023	Beschreibung	Modelle		Abmessungen		Preis €
	Kühlplatte mit integriertem Aggregat	AR1GPR1L	1	400x650	0,25/28	2.204,00
		AR2GPR1L	2	770x650	0,56/55	2.927,00
		AR3GPR1L	3	1100x650	0,79/60	3.198,00
		AR4GPR1L	4	1420x650	0,98/65	3.944,00
		AR5GPR1L	5	1745x650	1,20/75	4.156,00
		AR6GPR1L	6	2070x650	1,40/85	4.611,00
	Kühlplatte auf zwei Ebenen mit integriertem Aggregat	AR2GPR2L	2	770x650xh.65	0,56/55	4.593,00
		AR3GPR2L	3	1100x650xh.65	0,79/60	4.835,00
		AR4GPR2L	4	1420x650xh.65	0,98/65	5.147,00
		AR5GPR2L	5	1745x650xh.65	1,20/75	5.308,00
		AR6GPR2L	6	2070x650xh.65	1,40/85	5.558,00
	Kühlplatte aus Granit oder aus Verbundwerkstoff mit integriertem Aggregat	AR2GPR1LG	2	770x650	0,56/60	*
		AR3GPR1LG	3	1100x650	0,79/67	*
		AR4GPR1LG	4	1420x650	0,98/73	*
		AR5GPR1LG	5	1745x650	1,20/85	*
		AR6GPR1LG	6	2070x650	1,40/98	*
	Rahmenlose Kühlplatte aus Granit oder aus Verbundwerkstoff, mit integriertem Aggregat	AR1GPR1LGS	1	400x650		*
		AR2GPR1LGS	2	770x650		*
		AR3GPR1LGS	3	1100x650		*
		AR4GPR1LGS	4	1420x650		*
		AR5GPR1LGS	5	1745x650		*
		AR6GPR1LGS	6	2070x650		*
	Kühlplatte aus Granit oder aus Verbundwerkstoff auf 2 Ebenen mit integriertem Aggregat	AR2GPR2LG	2	770x650xh.65	0,56/75	*
		AR3GPR2LG	3	1100x650xh.65	0,79/82	*
		AR4GPR2LG	4	1420x650xh.65	0,98/89	*
		AR5GPR2LG	5	1745x650xh.65	1,20/101	*
		AR6GPR2LG	6	2070x650xh.65	1,40/113	*
	Kühlplatte mit 30 mm abgesenkter Auslagefläche mit integriertem Aggregat	AR1GPRR	1	400x650	0,25/28	2.081,00
		AR2GPRR	2	770x650	0,56/55	2.535,00
		AR3GPRR	3	1100x650	0,79/60	2.701,00
		AR4GPRR	4	1420x650	0,98/65	3.046,00
		AR5GPRR	5	1745x650	1,20/75	3.354,00
		AR6GPRR	6	2070x650	1,40/85	3.890,00
	Statisches Kühlbecken Tiefe 110 mm mit integriertem Aggregat	AR1GVRSB	1	400x650	0,25/28	2.850,00
		AR2GVRSB	2	770x650	0,63/59	3.298,00
		AR3GVRSB	3	1100x650	0,89/69	3.628,00
		AR4GVRSB	4	1420x650	1,10/84	3.991,00
		AR5GVRSB	5	1745x650	1,35/94	4.287,00
		AR6GVRSB	6	2070x650	1,57/99	4.815,00
	Statisches Kühlbecken Tiefe 215 mm mit integriertem Aggregat	AR1GVRSA	1	400x650	0,30/35	2.850,00
		AR2GVRSA	2	770x650	0,63/60	3.298,00
		AR3GVRSA	3	1100x650	0,89/70	3.628,00
		AR4GVRSA	4	1420x650	1,10/85	3.991,00
		AR5GVRSA	5	1745x650	1,35/95	4.168,00
		AR6GVRSA	6	2070x650	1,57/100	4.815,00

PREISLISTE 2023	Beschreibung	Modelle		Abmessungen		Preis €
	Umluft-Kühlplatte mit integriertem Aggregat	AR2GPRV AR3GPRV AR4GPRV AR5GPRV AR6GPRV	2 3 4 5 6	770x650 1100x650 1420x650 1745x650 2070x650		3.892,00 4.139,00 4.430,00 4.959,00 5.524,00
	Umluft-Kühlbecken mit integriertem Aggregat	AR2GVRV AR3GVRV AR4GVRV AR5GVRV AR6GVRV	- - - - -	770x650 1100x650 1420x650 1745x650 2070x650	0,65/95 0,90/110 1,18/120 1,42/145 1,64/165	5.020,00 5.341,00 5.718,00 6.397,00 7.124,00
	Kühlplatte, für Zentral-Kühlung	AR1RPR1L AR2RPR1L AR3RPR1L AR4RPR1L AR5RPR1L AR6RPR1L	1 2 3 4 5 6	400x650 770x650 1100x650 1420x650 1745x650 2070x650	0,20/18 0,49/30 0,69/35 0,86/40 1,05/45 1,22/50	1.866,00 2.268,00 2.887,00 3.272,00 3.467,00 3.958,00
	Kühlplatte auf zwei Ebenen, für Zentral-Kühlung	AR2RPR2L AR3RPR2L AR4RPR2L AR5RPR2L AR6RPR2L	2 3 4 5 6	770x650xh.65 1100x650xh.65 1420x650xh.65 1745x650xh.65 2070x650xh.65	0,49/30 0,69/35 0,86/40 1,05/45 1,22/50	3.897,00 4.197,00 4.467,00 4.612,00 4.822,00
	Rahmenlose Kühlplatte aus Granit oder aus Verbundwerkstoff, für Zentral-Kühlung.	AR1RPR1LGS AR2RPR1LGS AR3RPR1LGS AR4RPR1LGS AR5RPR1LGS AR6RPR1LGS	1 2 3 4 5 6	400x650 770x650 1100x650 1420x650 1745x650 2070x650		* * * * * *
	Kühlplatte aus Granit oder aus Verbundwerkstoff, für Zentral-Kühlung	AR1RPR1LG AR2RPR1LG AR3RPR1LG AR4RPR1LG AR5RPR1LG AR6RPR1LG	1 2 3 4 5 6	400x650 770x650 1100x650 1420x650 1745x650 2070x650	0,20/20 0,49/40 0,69/52 0,86/63 1,05/70 1,22/83	* * * * * *
	Kühlplatte aus Granit oder aus Verbundwerkstoff auf 2 Ebenen, für Zentral-Kühlung	AR2RPR2LG AR3RPR2LG AR4RPR2LG AR5RPR2LG AR6RPR2LG	2 3 4 5 6	770x650xh.65 1100x650xh.65 1420x650xh.65 1745x650xh.65 2070x650xh.65	0,49/50 0,69/57 0,86/64 1,05/71 1,22/78	* * * * *
	Kühlplatte mit 30 mm abgesenkter Auslagefläche, für Zentral-Kühlung	AR1RPRR AR2RPRR AR3RPRR AR4RPRR AR5RPRR AR6RPRR	1 2 3 4 5 6	400x650 770x650 1100x650 1420x650 1745x650 2070x650	0,20/18 0,49/30 0,69/35 0,86/40 1,05/45 1,22/50	1.763,00 1.995,00 2.226,00 2.453,00 2.812,00 3.183,00

PREISLISTE 2023	Beschreibung	Modelle		Abmessungen		Preis €
	Statisches Kühlbecken Tiefe. 110 mm, für Zentral-Kühlung	AR1RVRSB	1	400x650	0,20/18	2.228,00
		AR2RVRSB	2	770x650	0,49/30	2.584,00
		AR3RVRSB	3	1100x650	0,69/35	2.739,00
		AR4RVRSB	4	1420x650	0,86/40	3.118,00
		AR5RVRSB	5	1745x650	1,05/45	3.404,00
		AR6RVRSB	6	2070x650	1,22/50	3.925,00
	Statisches Kühlbecken Tiefe 215 mm, für Zentral-Kühlung	AR1RVRSA	1	400x650	0,20/25	2.228,00
		AR2RVRSA	2	770x650	0,49/35	2.584,00
		AR3RVRSA	3	1100x650	0,69/45	2.739,00
		AR4RVRSA	4	1420x650	0,86/50	3.118,00
		AR5RVRSA	5	1745x650	1,05/60	3.404,00
		AR6RVRSA	6	2070x650	1,22/70	3.925,00
	Umluft-Kühlplatte, für Zentral-Kühlung	AR2RPRV	2	770x650		3.240,00
		AR3RPRV	3	1100x650		3.489,00
		AR4RPRV	4	1420x650		3.793,00
		AR5RPRV	5	1745x650		4.376,00
		AR6RPRV	6	2070x650		4.883,00
	Umluft-Kühlbecken, für Zentral-Kühlung	AR2RVRV	-	770x650	0,49/50	4.179,00
		AR3RVRV	-	1100x650	0,69/60	4.499,00
		AR4RVRV	-	1420x650	0,86/75	4.892,00
		AR5RVRV	-	1745x650	1,05/85	5.645,00
		AR6RVRV	-	2070x650	1,22/105	6.299,00
	Isoliertes Becken Tiefe 110 mm	AR1VI	1	400x650	0,20/18	1.143,00
		AR2VI	2	770x650	0,49/30	1.440,00
		AR3VI	3	1100x650	0,69/35	1.649,00
		AR4VI	4	1420x650	0,86/40	1.808,00
		AR5VI	5	1745x650	1,05/45	1.957,00
		AR6VI	6	2070x650	1,22/50	2.272,00
	Umluft-Warmhaltebecken	AR1VCV	1	400x650	0,25/15	1.827,00
		AR2VCV	2	770x650	0,49/40	2.317,00
		AR3VCV	3	1100x650	0,79/50	2.502,00
		AR4VCV	4	1420x650	0,88/60	3.051,00
		AR5VCV	5	1745x650	1,02/90	3.569,00
		AR6VCV	6	2070x650	1,57/110	4.265,00
	Bain-Marie-Becken	AR1BMA	1	400x650	0,20/12	1.465,00
		AR2BMA	2	770x650	0,56/35	1.983,00
		AR3BMA	3	1100x650	0,79/45	2.260,00
		AR4BMA	4	1420x650	0,88/50	2.585,00
		AR5BMA	5	1745x650	1,02/80	2.974,00
		AR6BMA	6	2070x650	1,57/100	3.526,00
	Glaskeramik-Warmhalteplatte	AR1PMV	1	400x650	0,20/12	1.942,00
		AR2PMV	2	770x650	0,49/35	2.417,00
		AR3PMV	3	1100x650	0,69/45	2.691,00
		AR4PMV	4	1420x650	0,86/65	3.848,00
		AR5PMV	5	1745x650	1,05/80	4.236,00
		AR6PMV	6	2070x650	1,22/100	4.626,00

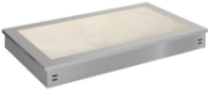
## ARIES

PREISLISTE 2023	Beschreibung	Modelle		Abmessungen		Preis €
	Rahmenlose Glaskeramik-Warmhalteplatte	AR1PMVS AR2PMVS AR3PMVS AR4PMVS AR5PMVS	1 2 3 4 5	400x650 770x650 1100x650 1420x650 1745x650		1.942,00 2.417,00 2.691,00 3.848,00 4.236,00
	Schwarze Hartglas-Warmhalteplatte	AR1PMT AR2PMT AR3PMT AR4PMT AR5PMT AR6PMT	1 2 3 4 5 6	400x650 770x650 1100x650 1420x650 1745x650 2070x650	0,20/12 0,49/35 0,69/45 0,86/65 1,05/80 1,22/100	1.063,00 1.714,00 1.979,00 2.450,00 2.711,00 3.175,00
	Rahmenlose Warmhalteplatte aus schwarzem Hartglas	AR1PMTS AR2PMTS AR3PMTS AR4PMTS AR5PMTS AR6PMTS	1 2 3 4 5 6	400x650 770x650 1100x650 1420x650 1745x650 2070x650		1.063,00 1.714,00 1.979,00 2.450,00 2.711,00 3.175,00
	Warmhalteplatte aus Verbundwerkstoff	AR1PMC AR2PMC AR3PMC AR4PMC AR5PMC AR6PMC	1 2 3 4 5 6	770x650xh.490 770x650xh.490 1100x650xh.490 1420x650xh.490 1745x650xh.490 2070x650xh.490	0,49/35 0,49/35 0,69/45 0,86/65 1,05/80 1,22/100	* * * * * *
	Rahmenlose Warmhalteplatte aus Verbundwerkstoff	AR1PMCS AR2PMCS AR3PMCS AR4PMCS AR5PMCS AR6PMCS	1 2 3 4 5 6	770x650xh.490 770x650xh.490 1100x650xh.490 1420x650xh.490 1745x650xh.490 2070x650xh.490	0,49/35 0,49/35 0,69/45 0,86/65 1,05/80 1,22/100	* * * * * *
	Neutraler Tellerspender, für Teller Ø 200 ÷ 260 mm	ARSN26	-	Ø 345 – H. 640	0,15/9	904,00
	Beheizter Tellerspender mit Deckel, für Teller Ø 200 ÷ 260 mm	ARSC26	-	Ø 345 – H. 640	0,15/11	2.061,00
	Neutraler Tellerspender, für Teller Ø 260 ÷ 310 mm	ARSN31	-	Ø 420 – H. 640	0,17/10	967,00











PREISLISTE 2023	Beschreibung	Modelle		Abmessungen		Preis €
	Beheizter Tellerspender mit Deckel, für Teller Ø 260 ÷ 310 mm	ARSC31	-	Ø 420 – H. 640	0,17/12	2.160,00
	Neutraler Tellerspender mit 2 Röhren, für Teller Ø 200 ÷ 260 mm	ARSND26	-	345x650xH.640	0,30/18	1.694,00
	Beheizter Tellerspender mit 2 Röhren und 2 Deckel, für Teller Ø 200 ÷ 260 mm	ARSCD26	-	345x650xH.640	0,30/20	3.945,00
	Neutraler Tellerspender mit 2 Röhren, für Teller Ø 260 ÷ 310 mm	ARSND31	-	380x760xH.640	0,34/20	1.935,00
	Beheizter Tellerspender mit 2 Röhren und 2 Deckel, für Teller Ø 260 ÷ 310 mm	ARSCD31	-	380x760xH.640	0,34/22	4.079,00
	Neutraler Korbspender	ARSNC	-	650x650	0,45/18	2.031,00
	Beheizter Korbspender	ARSCC	-	760x650	0,45/22	2.576,00



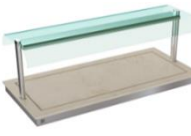
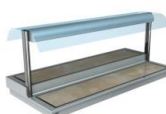





## LIBRA

PREISLISTE 2023	Beschreibung	Modelle		Abmessungen		Preis €
	Kühlplatte mit integriertem Aggregat	LI2GPR1L	2	770x650xh.490	0,56/55	3.408,00
		LI3GPR1L	3	1100x650xh.490	0,79/60	4.103,00
		LI4GPR1L	4	1420x650xh.490	0,98/65	4.647,00
		LI5GPR1L	5	1745x650xh.490	1,20/75	4.946,00
		LI6GPR1L	6	2070x650xh.490	1,40/85	5.541,00
	Kühlplatte auf 2 Ebenen mit integriertem Aggregat	LI2GPR2L	2	770x650xh.490	0,56/55	5.178,00
		LI3GPR2L	3	1100x650xh.490	0,79/60	5.423,00
		LI4GPR2L	4	1420x650xh.490	0,98/65	5.877,00
		LI5GPR2L	5	1745x650xh.490	1,20/75	6.111,00
		LI6GPR2L	6	2070x650xh.490	1,40/85	6.510,00
	Kühlplatte aus Granit oder Verbundwerkstoff mit integriertem Aggregat	LI2GPR1LG	2	770x650xh.490		*
		LI3GPR1LG	3	1100x650xh.490		*
		LI4GPR1LG	4	1420x650xh.490		*
		LI5GPR1LG	5	1745x650xh.490		*
		LI6GPR1LG	6	2070x650xh.490		*
	Rahmenlose Kühlplatte aus Granit oder Verbundwerkstoff mit integriertem Aggregat	LI2GPR1LGS	2	770x650xh.490	0,56/60	*
		LI3GPR1LGS	3	1100x650xh.490	0,79/67	*
		LI4GPR1LGS	4	1420x650xh.490	0,98/73	*
		LI5GPR1LGS	5	1745x650xh.490	1,20/85	*
		LI6GPR1LGS	6	2070x650xh.490	1,40/98	*
	Kühlplatte aus Granit oder Verbundwerkstoff auf 2 Ebenen mit integriertem Aggregat	LI2GPR2LG	2	770x650xh.490	0,56/75	*
		LI3GPR2LG	3	1100x650xh.490	0,79/82	*
		LI4GPR2LG	4	1420x650xh.490	0,98/89	*
		LI5GPR2LG	5	1745x650xh.490	1,20/101	*
		LI6GPR2LG	6	2070x650xh.490	1,40/113	*
	Kühlplatte mit 30 mm abgesenkter Auslagefläche mit integriertem Aggregat	LI2GPRR	2	770x650xh.490	0,56/55	3.064,00
		LI3GPRR	3	1100x650xh.490	0,79/60	3.408,00
		LI4GPRR	4	1420x650xh.490	0,98/65	3.984,00
		LI5GPRR	5	1745x650xh.490	1,20/75	4.299,00
		LI6GPRR	6	2070x650xh.490	1,40/85	4.754,00
	Umluft-Kühlplatte mit integriertem Aggregat	LI2GPRV	2	770x650xh.490		4.443,00
		LI3GPRV	3	1100x650xh.490		4.742,00
		LI4GPRV	4	1420x650xh.490		5.171,00
		LI5GPRV	5	1745x650xh.490		5.840,00
		LI6GPRV	6	2070x650xh.490		6.466,00
	Statisches Kühlbecken Tiefe 110 mm mit integriertem Aggregat	LI2GVRSB	2	770x650xh.490	0,63/59	3.849,00
		LI3GVRSB	3	1100x650xh.490	0,89/69	4.229,00
		LI4GVRSB	4	1420x650xh.490	1,10/84	4.650,00
		LI5GVRSB	5	1745x650xh.490	1,35/94	4.891,00
		LI6GVRSB	6	2070x650xh.490	1,57/99	5.775,00
	Statisches Kühlbecken Tiefe 215 mm mit integriertem Aggregat	LI2GVRSA	2	770x650xh.490	0,63/60	3.849,00
		LI3GVRSA	3	1100x650xh.490	0,89/70	4.229,00
		LI4GVRSA	4	1420x650xh.490	1,10/85	4.650,00
		LI5GVRSA	5	1745x650xh.490	1,35/95	4.891,00
		LI6GVRSA	6	2070x650xh.490	1,57/100	5.775,00



**LIBRA**

<b>PREISLISTE</b> 2023	<b>Beschreibung</b>	<b>Modelle</b>		<b>Abmessungen</b>		<b>Preis</b> €
	Umluft-Kühlbecken mit integriertem Aggregat	LI2GVRV LI3GVRV LI4GVRV LI5GVRV LI6GVRV	- - - - -	770x650xh.490 1100x650xh.490 1420x650xh.490 1745x650xh.490 2070x650xh.490	1,01/83 1,96/94 2,14/117 2,51/132 2,86/167	5.571,00 5.944,00 6.457,00 7.277,00 8.067,00
	Kühlplatte, für Zentral-Kühlung	LI2RPR1L LI3RPR1L LI4RPR1L LI5RPR1L LI6RPR1L	2 3 4 5 6	770x650xh.490 1100x650xh.490 1420x650xh.490 1745x650xh.490 2070x650xh.490	0,49/30 0,69/35 0,86/40 1,05/45 1,22/50	2.786,00 3.489,00 3.966,00 4.242,00 4.807,00
	Kühlplatte auf 2 Ebenen, für Zentral-Kühlung	LI2RPR2L LI3RPR2L LI4RPR2L LI5RPR2L LI6RPR2L	2 3 4 5 6	770x650xh.490 1100x650xh.490 1420x650xh.490 1745x650xh.490 2070x650xh.490	0,49/30 0,69/35 0,86/40 1,05/45 1,22/50	4.533,00 4.784,00 5.211,00 5.453,00 5.721,00
	Kühlplatte aus Granit oder Verbundwerkstoff, für Zentral-Kühlung	LI2RPR1LG LI3RPR1LG LI4RPR1LG LI5RPR1LG LI6RPR1LG	2 3 4 5 6	770x650xh.490 1100x650xh.490 1420x650xh.490 1745x650xh.490 2070x650xh.490	0,49/40 0,69/52 0,86/63 1,05/70 1,22/83	* * * * *
	Rahmenlose Kühlplatte aus Granit oder Verbundwerkstoff, für Zentral-Kühlung	LI2RPR1LGS LI3RPR1LGS LI4RPR1LGS LI5RPR1LGS LI6RPR1LGS	2 3 4 5 6	770x650xh.490 1100x650xh.490 1420x650xh.490 1745x650xh.490 2070x650xh.490	0,49/40 0,69/52 0,86/63 1,05/70 1,22/83	* * * * *
	Kühlplatte Granit oder Verbundwerkstoff auf 2 Ebenen, für Zentral-Kühlung	LI2RPR2LG LI3RPR2LG LI4RPR2LG LI5RPR2LG LI6RPR2LG	2 3 4 5 6	770x650xh.490 1100x650xh.490 1420x650xh.490 1745x650xh.490 2070x650xh.490	0,49/50 0,69/57 0,86/64 1,05/71 1,22/78	* * * * *
	Kühlplatte mit 30 mm abgesenkter Auslagefläche mit integriertem Aggregat, für Zentral-Kühlung	LI2RPRR LI3RPRR LI4RPRR LI5RPRR LI6RPRR	2 3 4 5 6	770x650xh.490 1100x650xh.490 1420x650xh.490 1745x650xh.490 2070x650xh.490	0,49/30 0,69/35 0,86/40 1,05/45 1,22/50	2.433,00 2.819,00 3.294,00 3.552,00 3.984,00
	Umluft-Kühlplatte, für Zentral-Kühlung	LI2RPRV LI3RPRV LI4RPRV LI5RPRV LI6RPRV	2 3 4 5 6	770x650xh.490 1100x650xh.490 1420x650xh.490 1745x650xh.490 2070x650xh.490		3.791,00 4.093,00 4.534,00 5.257,00 5.824,00
	Statisches Kühlbecken Tiefe 110 mm, für Zentral-Kühlung	LI2RVRSB LI3RVRSB LI4RVRSB LI5RVRSB LI6RVRSB	2 3 4 5 6	770x650xh.490 1100x650xh.490 1420x650xh.490 1745x650xh.490 2070x650xh.490	0,49/30 0,69/35 0,86/40 1,05/45 1,22/50	3.210,00 3.548,00 3.871,00 4.319,00 4.755,00

## LIBRA









PREISLISTE 2023	Beschreibung	Modelle		Abmessungen		Preis €
	Statisches Kühlbecken Tiefe 215 mm, für Zentral-Kühlung	LI2RVRSA	2	770x650xh.490	0,49/35	3.210,00
		LI3RVRSA	3	1100x650xh.490	0,69/45	3.548,00
		LI4RVRSA	4	1420x650xh.490	0,86/50	3.871,00
		LI5RVRSA	5	1745x650xh.490	1,05/60	4.319,00
		LI6RVRSA	6	2070x650xh.490	1,22/70	4.755,00
	Umluft-Kühlbecken, für Zentral-Kühlung	LI2RVRV	-	770x650xh.490	1,04/63	4.785,00
		LI3RVRV	-	1100x650xh.490	1,39/70	4.981,00
		LI4RVRV	-	1420x650xh.490	1,59/77	5.684,00
		LI5RVRV	-	1745x650xh.490	1,89/88	6.123,00
		LI6RVRV	-	2070x650xh.490	1,96/98	7.109,00
	Isoliertes Becken Tiefe 110 mm	LI2VI	2	770x650xh.490	0,49/30	1.830,00
		LI3VI	3	1100x650xh.490	0,69/35	2.303,00
		LI4VI	4	1420x650xh.490	0,86/40	2.431,00
		LI5VI	5	1745x650xh.490	1,05/45	2.918,00
		LI6VI	6	2070x650xh.490	1,22/50	3.055,00
	Umluft-Warmhaltebecken	LI2VCV	2	770x650xh.490	0,79/50	2.785,00
		LI3VCV	3	1100x650xh.490	0,88/58	3.252,00
		LI4VCV	4	1420x650xh.490	1,02/94	3.809,00
		LI5VCV	5	1745x650xh.490	1,57/118	4.495,00
		LI6VCV	6	2070x650xh.490	0,90/136	5.268,00
	Bain-Marie Becken	LI2BMA	2	770x650xh.490	0,79/45	2.484,00
		LI3BMA	3	1100x650xh.490	0,88/50	2.828,00
		LI4BMA	4	1420x650xh.490	1,02/80	3.090,00
		LI5BMA	5	1745x650xh.490	1,57/100	3.622,00
		LI6BMA	6	2070x650xh.490	1,90/120	4.274,00
	Glaskeramik-Warmhalteplatte	LI2PMV	2	770x650xh.490	0,49/35	2.828,00
		LI3PMV	3	1100x650xh.490	0,69/45	3.222,00
		LI4PMV	4	1420x650xh.490	0,86/65	4.251,00
		LI5PMV	5	1745x650xh.490	1,05/80	4.851,00
		LI6PMV	6	2070x650xh.490	1,22/100	5.320,00
	Rahmenlose Glaskeramik-Warmhalteplatte	LI2PMVS	2	770x650xh.490	0,49/35	2.828,00
		LI3PMVS	3	1100x650xh.490	0,69/45	3.222,00
		LI4PMVS	4	1420x650xh.490	0,86/65	4.251,00
		LI5PMVS	5	1745x650xh.490	1,05/80	4.851,00
		LI6PMVS	6	2070x650xh.490	1,22/100	5.320,00
	Schwarze Hartglas-Warmhalteplatte	LI2PMT	2	770x650xh.490	0,49/35	2.229,00
		LI3PMT	3	1100x650xh.490	0,69/45	2.551,00
		LI4PMT	4	1420x650xh.490	0,86/65	3.080,00
		LI5PMT	5	1745x650xh.490	1,05/80	3.398,00
		LI6PMT	6	2070x650xh.490	1,22/100	3.919,00
	Rahmenlose Warmhalteplatte aus schwarzem Hartglas	LI2PMTS	2	770x650xh.490	0,49/35	2.229,00
		LI3PMTS	3	1100x650xh.490	0,69/45	2.551,00
		LI4PMTS	4	1420x650xh.490	0,86/65	3.079,00
		LI5PMTS	5	1745x650xh.490	1,05/80	3.398,00
		LI6PMTS	6	2070x650xh.490	1,22/100	3.919,00

## LIBRA









PREISLISTE 2023	Beschreibung	Modelle		Abmessungen		Preis €
	Warmhalteplatte aus Verbundwerkstoff	LI2PMC	2	770x650xh.490	0,49/35	*
		LI3PMC	3	1100x650xh.490	0,69/45	*
		LI4PMC	4	1420x650xh.490	0,86/65	*
		LI5PMC	5	1745x650xh.490	1,05/80	*
		LI6PMC	6	2070x650xh.490	1,22/100	*
			Rahmenlose Warmhalteplatte aus Verbundwerkstoff	LI2PMCS	2	770x650xh.490
LI3PMCS	3			1100x650xh.490	0,69/45	*
LI4PMCS	4			1420x650xh.490	0,86/65	*
LI5PMCS	5			1745x650xh.490	1,05/80	*
LI6PMCS	6			2070x650xh.490	1,22/100	*



\* a richiesta / sur demande / auf Anfrage / on request

# PEGASUS

PREISLISTE 2023	Beschreibung	Modelle		Abmessungen		Preis €
	Umluft-Kühlbecken mit Aufbau und integriertem Aggregat	PE3GVRV	2	770x870xh.490	1,90/112	5.913,00
		PE3GVRV	3	1100x870xh.490	2,10/133	6.463,00
		PE4GVRV	4	1420x870xh.490	2,40/155	6.940,00
		PE5GVRV	5	1745x870xh.490	2,76/189	7.753,00
		PE6GVRV	6	2070x870xh.490	3,30/219	8.616,00
	Umluft-Kühlbecken ohne Aufbau, mit integriertem Aggregat	PE2GVRVS	2	770x870	1,75/97	5.410,00
		PE3GVRVS	3	1100x870	1,90/113	5.897,00
		PE4GVRVS	4	1420x870	2,15/130	6.280,00
		PE5GVRVS	5	1745x870	2,46/159	7.030,00
		PE6GVRVS	6	2070x870	2,75/196	7.656,00
	Umluft-Kühlplatte mit Aufbau und integriertem Aggregat	PE3GPRV	2	770x870xh.490		4.744,00
		PE3GPRV	3	1100x870xh.490		5.183,00
		PE4GPRV	4	1420x870xh.490		5.778,00
		PE5GPRV	5	1745x870xh.490		6.898,00
		PE6GPRV	6	2070x870xh.490		7.490,00
	Umluft-Kühlplatte ohne Aufbau, mit integriertem Aggregat	PE2GPRVS	2	770x870		4.530,00
		PE3GPRVS	3	1100x870		4.945,00
		PE4GPRVS	4	1420x870		5.440,00
		PE5GPRVS	5	1745x870		5.948,00
		PE6GPRVS	6	2070x870		5.993,00
	Umluft-Kühlbecken mit Aufbau, für Zentral-Kühlung	PE3RVRV	2	770x870xh.490	1,42/72	5.179,00
		PE3RVRV	3	1100x870xh.490	1,68/84	5.660,00
		PE4RVRV	4	1420x870xh.490	1,94/96	6.113,00
		PE5RVRV	5	1745x870xh.490	2,03/108	6.951,00
		PE6RVRV	6	2070x870xh.490	2,34/120	7.789,00
	Umluft-Kühlbecken ohne Aufbau, für Zentral-Kühlung	PE2RVRVS	2	770x870	1,27/61	4.675,00
		PE3RVRVS	3	1100x870	1,48/66	5.094,00
		PE4RVRVS	4	1420x870	1,63/73	5.454,00
		PE5RVRVS	5	1745x870	1,74/82	6.227,00
		PE6RVRVS	6	2070x870	1,88/96	6.830,00
	Umluft-Kühlplatte mit Aufbau, für Zentral-Kühlung	PE2RPRV	2	770x870xh.490		4.174,00
		PE3RPRV	3	1100x870xh.490		4.553,00
		PE4RPRV	4	1420x870xh.490		5.112,00
		PE5RPRV	5	1745x870xh.490		5.709,00
		PE6RPRV	6	2070x870xh.490		6.237,00
	Umluft-Kühlplatte ohne Aufbau, für Zentral-Kühlung	PE2RPRVS	2	770x870	1,27/61	3.623,00
		PE3RPRVS	3	1100x870	1,48/66	3.950,00
		PE4RPRVS	4	1420x870	1,63/73	4.371,00
		PE5RPRVS	5	1745x870	1,74/82	4.829,00
		PE6RPRVS	6	2070x870	1,88/96	5.295,00

# VIRGO

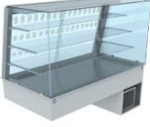
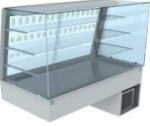

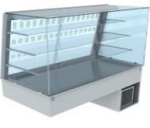
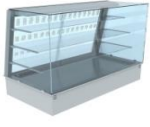
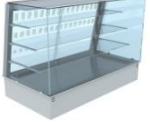
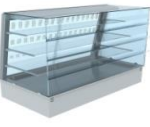
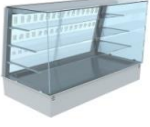
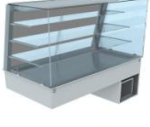
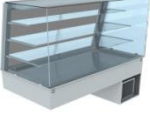
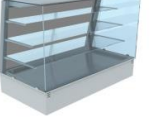





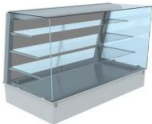
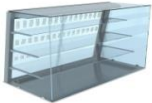
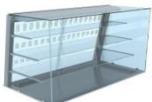

PREISLISTE 2023	Beschreibung	Modelle		Abmessungen		Preis €
	Offene Umluft-Kühlvitrine mit Split-Aggregat	VI2SRA	-	840x650xh.800	1,54/125	9.276,00
		VI3SRA	-	1180x650xh.800	2,12/155	9.937,00
		VI4SRA	-	1530x650xh.800	2,42/191	10.598,00
		VI5SRA	-	1870x650xh.800	2,80/229	11.295,00
	Umluft-Kühlvitrine mit Klappen und Split-Aggregat	VI2SRF	-	840x650xh.800	1,54/125	9.867,00
		VI3SRF	-	1180x650xh.800	2,12/155	10.717,00
		VI4SRF	-	1530x650xh.800	2,42/191	11.283,00
		VI5SRF	-	1870x650xh.800	2,80/229	12.140,00
	Offene Umluft-Kühlvitrine, für Zentral-Kühlung	VI2RRA	-	840x650xh.800	1,30/80	8.368,00
		VI3RRA	-	1180x650xh.800	1,80/103	8.840,00
		VI4RRA	-	1530x650xh.800	2,04/131	9.496,00
		VI5RRA	-	1870x650xh.800	2,20/159	10.043,00
	Umluft-Kühlvitrine mit Klappen, für Zentral-Kühlung	VI2RRF	-	840x650xh.800	1,30/80	8.993,00
		VI3RRF	-	1180x650xh.800	1,80/103	9.572,00
		VI4RRF	-	1530x650xh.800	2,04/131	10.126,00
		VI5RRF	-	1870x650xh.800	2,20/159	10.586,00
	Offene Umluft Wand-Kühlvitrine mit Split-Aggregat	VI2SRMA	-	840x650xh.800	1,54/125	9.276,00
		VI3SRMA	-	1180x650xh.800	2,12/155	9.937,00
		VI4SRMA	-	1530x650xh.800	2,42/191	10.598,00
		VI5SRMA	-	1870x650xh.800	2,80/229	11.295,00
	Offene Umluft Wand-Kühlvitrine, für Zentral-Kühlung	VI2RRMA	-	840x650xh.800	1,30/80	8.368,00
		VI3RRMA	-	1180x650xh.800	1,80/103	8.840,00
		VI4RRMA	-	1530x650xh.800	2,04/131	9.496,00
		VI5RRMA	-	1870x650xh.800	2,20/159	10.043,00
	Offene Neutralvitrine	VI2NA	-	840x650xh.800	0,95/43	2.177,00
		VI3NA	-	1180x650xh.800	1,30/48	2.457,00
		VI4NA	-	1530x650xh.800	1,50/52	2.691,00
		VI5NA	-	1870x650xh.800	1,75/57	2.939,00
	Neutralvitrine mit Klappen	VI2NF	-	840x650xh.800	0,95/43	2.813,00
		VI3NF	-	1180x650xh.800	1,30/48	3.189,00
		VI4NF	-	1530x650xh.800	1,50/52	3.527,00
		VI5NF	-	1870x650xh.800	1,75/57	3.877,00

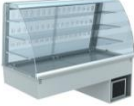
PREISLISTE 2023	Beschreibung	Modelle		Abmessungen		Preis €
	Offene Umluft-Kühlvitrine mit Split-Aggregat	LY2SRA LY3SRA LY4SRA LY5SRA	- - - -	840x650xh.800 1180x650xh.800 1530x650xh.800 1870x650xh.800	1,54/125 2,12/155 2,42/191 2,80/229	9.276,00 9.937,00 10.598,00 11.295,00
	Geschlossene Umluft-Kühlvitrine mit Split-Aggregat	LY2SRC LY3SRC LY4SRC LY5SRC	- - - -	840x650xh.800 1180x650xh.800 1530x650xh.800 1870x650xh.800	1,54/125 2,12/155 2,42/191 2,80/229	9.425,00 9.925,00 10.554,00 11.558,00
	Umluft-Kühlvitrine mit Klappen und Split-Aggregat	LY2SRF LY3SRF LY4SRF LY5SRF	- - - -	840x650xh.800 1180x650xh.800 1530x650xh.800 1870x650xh.800	1,54/125 2,12/155 2,42/191 2,80/229	9.867,00 10.717,00 11.283,00 12.140,00
	Umluft-Kühlvitrine mit Schiebetüren und Split-Aggregat	LY2SRP LY3SRP LY4SRP LY5SRP	- - - -	840x650xh.800 1180x650xh.800 1530x650xh.800 1870x650xh.800	1,54/125 2,12/155 2,42/191 2,80/229	9.867,00 10.717,00 11.283,00 12.140,00
	Offene Umluft-Kühlvitrine, für Zentral-Kühlung	LY2RRA LY3RRA LY4RRA LY5RRA	- - - -	840x650xh.800 1180x650xh.800 1530x650xh.800 1870x650xh.800	1,30/80 1,80/103 2,04/131 2,20/159	8.368,00 8.840,00 9.496,00 10.043,00
	Geschlossene Umluft-Kühlvitrine, für Zentral-Kühlung	LY2RRC LY3RRC LY4RRC LY5RRC	- - - -	840x650xh.800 1180x650xh.800 1530x650xh.800 1870x650xh.800	1,30/80 1,80/103 2,04/131 2,20/159	8.569,00 9.064,00 9.661,00 10.106,00
	Umluft-Kühlvitrine mit Klappen, für Zentral-Kühlung	LY2RRF LY3RRF LY4RRF LY5RRF	- - - -	840x650xh.800 1180x650xh.800 1530x650xh.800 1870x650xh.800	1,30/80 1,80/103 2,04/131 2,20/159	8.993,00 9.572,00 10.126,00 10.586,00
	Umluft-Kühlvitrine mit Schiebetüren, für Zentral-Kühlung	LY2RRP LY3RRP LY4RRP LY5RRP	- - - -	840x650xh.800 1180x650xh.800 1530x650xh.800 1870x650xh.800	1,30/80 1,80/103 2,04/131 2,20/159	8.993,00 9.572,00 10.126,00 10.586,00
	Offene Umluft Wand-Kühlvitrine mit Split-Aggregat	LY2SRMA LY3SRMA LY4SRMA LY5SRMA	- - - -	840x650xh.800 1180x650xh.800 1530x650xh.800 1870x650xh.800	1,54/125 2,12/155 2,42/191 2,80/229	9.276,00 9.937,00 10.598,00 11.295,00
	Umluft Wand-Kühlvitrine mit Schiebetüren und Split-Aggregat	LY2SRMP LY3SRMP LY4SRMP LY5SRMP	- - - -	840x650xh.800 1180x650xh.800 1530x650xh.800 1870x650xh.800	1,54/125 2,12/155 2,42/191 2,80/229	9.867,00 10.717,00 11.283,00 12.140,00
	Offene Umluft Wand-Kühlvitrine, für Zentral-Kühlung	LY2RRMA LY3RRMA LY4RRMA LY5RRMA	- - - -	840x650xh.800 1180x650xh.800 1530x650xh.800 1870x650xh.800	1,30/80 1,80/103 2,04/131 2,20/159	8.368,00 8.840,00 9.496,00 10.043,00













# LYRA



PREISLISTE 2023	Beschreibung	Modelle		Abmessungen		Preis €
	Umluft Wand-Kühlvitrine mit Schiebetüren, für Zentral-Kühlung	LY2RRMP	-	840x650xh.800	1,30/80	8.993,00
		LY3RRMP	-	1180x650xh.800	1,80/103	9.572,00
		LY4RRMP	-	1530x650xh.800	2,04/131	10.126,00
		LY5RRMP	-	1870x650xh.800	2,20/159	10.586,00
	Offene Neutralvitrine	LY2NA	-	840x650xh.800	0,95/43	2.177,00
		LY3NA	-	1180x650xh.800	1,30/48	2.457,00
		LY4NA	-	1530x650xh.800	1,50/52	2.691,00
		LY5NA	-	1870x650xh.800	1,75/57	2.939,00
	Neutralvitrine mit Klappen	LY2NF	-	840x650xh.800	0,95/43	2.813,00
		LY3NF	-	1180x650xh.800	1,30/48	3.189,00
		LY4NF	-	1530x650xh.800	1,50/52	3.527,00
		LY5NF	-	1870x650xh.800	1,75/57	3.877,00



<b>PREISLISTE 2023</b>	<b>Beschreibung</b>	<b>Modelle</b>		<b>Abmessungen</b>		<b>Preis €</b>
	Offene Umluft-Kühlvitrine mit Split-Aggregat	GE2SRA GE3SRA GE4SRA GE5SRA	2 3 4 5	840x760xh.800 1180x760xh.800 1530x760xh.800 1870x760xh.800	1,74/130 2,41/162 2,75/200 3,18/240	9.276,00 9.937,00 10.598,00 11.295,00
	Offene Umluft Wand-Kühlvitrine mit Split-Aggregat	GE2SRMA GE3SRMA GE4SRMA GE5SRMA	2 3 4 5	840x760xh.800 1180x760xh.800 1530x760xh.800 1870x760xh.800	1,74/130 2,41/162 2,75/200 3,18/240	9.276,00 9.937,00 10.598,00 11.295,00
	Geschlossene Umluft-Kühlvitrine mit Split-Aggregat	GE2SRC GE3SRC GE4SRC GE5SRC	2 3 4 5	840x760xh.800 1180x760xh.800 1530x760xh.800 1870x760xh.800	1,74/130 2,41/162 2,75/200 3,18/240	9.425,00 9.925,00 10.554,00 11.558,00
	Umluft-Kühlvitrine mit Klappen und Split-Aggregat	GE2SRF GE3SRF GE4SRF GE5SRF	2 3 4 5	840x760xh.800 1180x760xh.800 1530x760xh.800 1870x760xh.800	1,74/130 2,41/162 2,75/200 3,18/240	9.867,00 10.717,00 11.283,00 12.140,00
	Umluft-Kühlbecken mit Aufbau und integriertem Aggregat	GE2GVRV GE3GVRV GE4GVRV GE5GVRV GE6GVRV	2 3 4 5 6	770x760xh.490 1100x760xh.490 1420x760xh.490 1745x760xh.490 2070x760xh.490	1,16/90 2,04/105 2,32/130 2,68/150 3,00/185	5.486,00 5.875,00 6.291,00 7.046,00 7.836,00
	Umluft-Kühlbecken ohne Aufbau, mit integriertem Aggregat	GE2GVRVS GE3GVRVS GE4GVRVS GE5GVRVS GE6GVRVS	2 3 4 5 6	770x760 1100x760 1420x760 1745x760 2070x760	0,75/102 1,06/121 1,36/135 1,57/163 1,78/186	5.020,00 5.341,00 5.718,00 6.397,00 7.124,00
	Umluft-Kühlplatte mit Aufbau und integriertem Aggregat	GE2GPRV GE3GPRV GE4GPRV GE5GPRV GE6GPRV	2 3 4 5 6	770x760xh.490 1100x760xh.490 1420x760xh.490 1745x760xh.490 2070x760xh.490		4.586,00 4.957,00 5.475,00 6.112,00 6.700,00
	Umluft-Kühlplatte ohne Aufbau, mit integriertem Aggregat	GE2GPRVS GE3GPRVS GE4GPRVS GE5GPRVS GE6GPRVS	2 3 4 5 6	770x760 1100x760 1420x760 1745x760 2070x760		4.036,00 4.353,00 4.734,00 5.232,00 5.759,00
	Offene Umluft-Kühlvitrine, für Zentral-Kühlung	GE2RRA GE3RRA GE4RRA GE5RRA	2 3 4 5	840x760xh.800 1180x760xh.800 1530x760xh.800 1870x760xh.800	1,47/85 2,04/110 2,32/140 2,50/170	8.368,00 8.840,00 9.496,00 10.043,00
	Offene Umluft Wand-Kühlvitrine, für Zentral-Kühlung	GE2RRMA GE3RRMA GE4RRMA GE5RRMA	2 3 4 5	840x760xh.800 1180x760xh.800 1530x760xh.800 1870x760xh.800	1,47/85 2,04/110 2,32/140 2,50/170	8.368,00 8.840,00 9.496,00 10.043,00

## GEMINI

PREISLISTE 2023	Beschreibung	Modelle		Abmessungen		Preis €
	Geschlossene Umluft-Kühlvitrine, für Zentral-Kühlung	GE2RRC	2	840x760xh.800	1,47/85	8.569,00
		GE3RRC	3	1180x760xh.800	2,04/110	9.064,00
		GE4RRC	4	1530x760xh.800	2,32/140	9.661,00
		GE5RRC	5	1870x760xh.800	2,50/170	10.106,00
	Umluft-Kühlvitrine mit Klappen, für Zentral-Kühlung	GE2RRF	2	840x760xh.800	1,47/85	8.993,00
		GE3RRF	3	1180x760xh.800	2,04/110	9.572,00
		GE4RRF	4	1530x760xh.800	2,32/140	10.126,00
		GE5RRF	5	1870x760xh.800	2,50/170	10.586,00
	Umluft-Kühlbecken mit Aufbau, für Zentral-Kühlung	GE2RVRV	2	770x760xh.490	1,08/70	4.683,00
		GE3RVRV	3	1100x760xh.490	1,49/80	5.073,00
		GE4RVRV	4	1420x760xh.490	1,70/90	5.489,00
		GE5RVRV	5	1745x760xh.490	1,96/100	6.279,00
		GE6RVRV	6	2070x760xh.490	2,10/110	7.010,00
	Umluft-Kühlbecken ohne Aufbau, für Zentral-Kühlung	GE2RVRVS	2	770x760	0,60/62	4.179,00
		GE3RVRVS	3	1100x760	0,91/74	4.499,00
		GE4RVRVS	4	1420x760	1,07/88	4.892,00
		GE5RVRVS	5	1745x760	1,28/103	5.645,00
		GE6RVRVS	6	2070x760	1,49/128	6.299,00
	Umluft-Kühlplatte mit Aufbau, für Zentral-Kühlung	GE2RPRV	2	770x760xh.490	1,08/70	3.983,00
		GE3RPRV	3	1100x760xh.490	1,49/80	4.324,00
		GE4RPRV	4	1420x760xh.490	1,70/90	4.822,00
		GE5RPRV	5	1745x760xh.490	1,96/100	5.482,00
		GE6RPRV	6	2070x760xh.490	2,10/110	6.031,00
	Umluft-Kühlplatte ohne Aufbau, für Zentral-Kühlung	GE2RPRVS	2	770x760	0,60/62	3.432,00
		GE3RPRVS	3	1100x760	0,91/74	3.721,00
		GE4RPRVS	4	1420x760	1,07/88	4.081,00
		GE5RPRVS	5	1745x760	1,28/103	4.602,00
		GE6RPRVS	6	2070x760	1,49/128	5.089,00
	Offene Neutralvitrine	GE2NA	2	840x760xh.800	1,05/45	2.177,00
		GE3NA	3	1180x760xh.800	1,45/50	2.457,00
		GE4NA	4	1530x760xh.800	1,65/55	2.691,00
		GE5NA	5	1870x760xh.800	1,95/60	2.939,00
	Neutralvitrine mit Klappen	GE2NF	2	840x760xh.800	1,05/45	2.813,00
		GE3NF	3	1180x760xh.800	1,45/50	3.189,00
		GE4NF	4	1530x760xh.800	1,65/55	8.527,00
		GE5NF	5	1870x760xh.800	1,95/60	3.877,00
	Offene Warmhaltevitrine mit Glaskeramikplatte	GE2MA	2	840x760xh.800	1,76/120	5.842,00
		GE3MA	3	1180x760xh.800	2,45/141	6.822,00
		GE4MA	4	1530x760xh.800	2,79/190	7.235,00
		GE5MA	5	1870x760xh.800	3,21/200	7.907,00
	Geschlossene Warmhaltevitrine mit Glaskeramikplatte	GE2MC	2	840x760xh.800	1,76/130	6.066,00
		GE3MC	3	1180x760xh.800	2,45/162	7.070,00
		GE4MC	4	1530x760xh.800	2,79/210	7.518,00
		GE5MC	5	1870x760xh.800	3,21/240	8.121,00

**GEMINI**

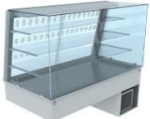
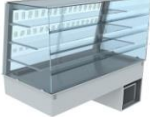

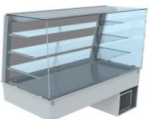
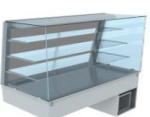
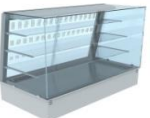
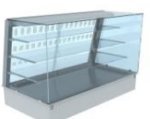
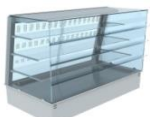
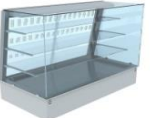
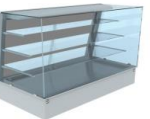
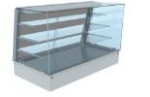
PREISLISTE 2023	Beschreibung	Modelle		Abmessungen		Preis €
	Geschlossene befeuchtete Warmhaltevitrine	GE2CU	2	840x760xh.800	1,47/75	8.112,00
		GE3CU	3	1180x760xh.800	2,04/105	8.675,00
		GE4CU	4	1530x760xh.800	2,32/140	8.961,00
		GE5CU	5	1870x760xh.800	2,68/175	9.542,00
	Geschlossene Umluft-Warmhaltevitrine	GE2CSV	2	840x760xh.800	1,47/73	5.995,00
		GE3CSV	3	1180x760xh.800	2,04/102	6.444,00
		GE4CSV	4	1530x760xh.800	2,32/138	6.833,00
		GE5CSV	5	1870x760xh.800	2,68/171	7.312,00

PREISLISTE 2023	Beschreibung	Modelle		Abmessungen		Preis €
	Offene Umluft-Kühlvitrine mit Split-Aggregat	VE2SRA	2	840x760xh.800	1,74/130	9.276,00
		VE3SRA	3	1180x760xh.800	2,41/162	9.937,00
		VE4SRA	4	1530x760xh.800	2,75/200	10.598,00
		VE5SRA	5	1870x760xh.800	3,18/240	11.295,00
	Geschlossene Umluft-Kühlvitrine mit Split-Aggregat	VE2SRC	2	840x760xh.800	1,74/130	9.425,00
		VE3SRC	3	1180x760xh.800	2,41/162	9.925,00
		VE4SRC	4	1530x760xh.800	2,75/200	10.554,00
		VE5SRC	5	1870x760xh.800	3,18/240	11.558,00
	Umluft-Kühlvitrine mit Klappen und Split-Aggregat	VE2SRF	2	840x760xh.800	1,74/130	9.867,00
		VE3SRF	3	1180x760xh.800	2,41/162	10.717,00
		VE4SRF	4	1530x760xh.800	2,75/200	11.283,00
		VE5SRF	5	1870x760xh.800	3,18/240	12.140,00
	Umluft-Kühlvitrine mit Schiebetüren und Split-Aggregat	VE2SRP	2	840x760xh.800	1,74/130	9.867,00
		VE3SRP	3	1180x760xh.800	2,41/162	10.717,00
		VE4SRP	4	1530x760xh.800	2,75/200	11.283,00
		VE5SRP	5	1870x760xh.800	3,18/240	12.140,00
	Offene Umluft Wand-Kühlvitrine mit Split-Aggregat	VE2SRMA	2	840x760xh.800	1,74/130	9.276,00
		VE3SRMA	3	1180x760xh.800	2,41/162	9.937,00
		VE4SRMA	4	1530x760xh.800	2,75/200	10.598,00
		VE5SRMA	5	1870x760xh.800	3,18/240	11.295,00
	Umluft Wand-Kühlvitrine mit Schiebetüren und Split-Aggregat	VE2SRMP	2	840x760xh.800	1,74/130	9.867,00
		VE3SRMP	3	1180x760xh.800	2,41/162	10.717,00
		VE4SRMP	4	1530x760xh.800	2,75/200	11.283,00
		VE5SRMP	5	1870x760xh.800	3,18/240	12.140,00
	Offene Umluft-Kühlvitrine, für Zentral-Kühlung	VE2RRA	2	840x760xh.800	1,47/85	8.368,00
		VE3RRA	3	1180x760xh.800	2,04/110	8.840,00
		VE4RRA	4	1530x760xh.800	2,32/140	9.496,00
		VE5RRA	5	1870x760xh.800	2,50/170	10.043,00
	Geschlossene Umluft-Kühlvitrine, für Zentral-Kühlung	VE2RRC	2	840x760xh.800	1,47/85	8.569,00
		VE3RRC	3	1180x760xh.800	2,04/110	9.064,00
		VE4RRC	4	1530x760xh.800	2,32/140	9.661,00
		VE5RRC	5	1870x760xh.800	2,50/170	10.106,00
	Umluft-Kühlvitrine mit Klappen, für Zentral-Kühlung	VE2RRF	2	840x760xh.800	1,47/85	8.993,00
		VE3RRF	3	1180x760xh.800	2,04/110	9.572,00
		VE4RRF	4	1530x760xh.800	2,32/140	10.126,00
		VE5RRF	5	1870x760xh.800	2,50/170	10.586,00
	Umluft-Kühlvitrine mit Schiebetüren, für Zentral-Kühlung	VE2RRP	2	840x760xh.800	1,47/85	8.993,00
		VE3RRP	3	1180x760xh.800	2,04/110	9.572,00
		VE4RRP	4	1530x760xh.800	2,32/140	10.126,00
		VE5RRP	5	1870x760xh.800	2,50/170	10.586,00
	Offene Umluft Wand-Kühlvitrine, für Zentral-Kühlung	VE2RRMA	2	840x760xh.800	1,47/85	8.368,00
		VE3RRMA	3	1180x760xh.800	2,04/110	8.840,00
		VE4RRMA	4	1530x760xh.800	2,32/140	9.496,00
		VE5RRMA	5	1870x760xh.800	2,50/170	10.043,00
	Umluft Wand-Kühlvitrine mit Schiebetüren, für Zentral-Kühlung	VE2RRMP	2	840x760xh.800	1,47/85	8.993,00
		VE3RRMP	3	1180x760xh.800	2,04/110	9.572,00
		VE4RRMP	4	1530x760xh.800	2,32/140	10.126,00

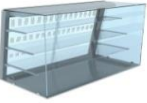
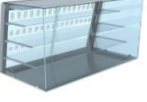







**VELA**

PREISLISTE 2023	Beschreibung	Modelle		Abmessungen		Preis €
	Offene Neutralvitrine	VE2NA	2	840x760xh.800	1,05/45	2.177,00
		VE3NA	3	1180x760xh.800	1,45/50	2.457,00
		VE4NA	4	1530x760xh.800	1,65/55	2.691,00
		VE5NA	5	1870x760xh.800	1,95/60	2.939,00
	Neutralvitrine mit Klappen	VE2NF	2	840x760xh.800	1,05/45	2.813,00
		VE3NF	3	1180x760xh.800	1,45/50	3.189,00
		VE4NF	4	1530x760xh.800	1,65/55	3.527,00
		VE5NF	5	1870x760xh.800	1,95/60	3.877,00

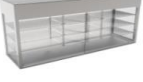
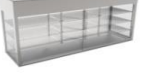
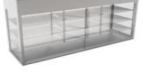
## TIFFANY





PREISLISTE 2023	Beschreibung	Modelle		Abmessungen	Preis €
	Panorama-Kühlvitrine mit Schublade(n) und integriertem Aggregat	TIG1C	1	665x795xh.240	6.354,00
		TIG2C	2	1300x795xh.240	7.659,00
		TIG3C	3	1935x795xh.240	9.544,00
	Panorama-Kühlvitrine mit Schublade(n), für Zentral-Kühlung	TIR1C	1	665x795xh.240	5.274,00
		TIR2C	2	1300x795xh.240	6.485,00
		TIR3C	3	1935x795xh.240	8.772,00
	Panorama-Warmhaltevitrine mit Schublade(n)	TIC1C	1	665x795xh.240	4.557,00
		TIC2C	2	1300x795xh.240	5.604,00
		TIC3C	3	1935x795xh.240	7.073,00
	Panorama-Neutralvitrine mit Schublade(n)	TIN1C	1	665x795xh.240	3.524,00
		TIN2C	2	1300x795xh.240	4.877,00
		TIN3C	3	1935x795xh.240	6.170,00

## GALAXY

PREISLISTE 2023	Beschreibung	Modelle	Abmessungen		Preis €
	Offene Umluft-Kühlvitrine mit Boden und integriertem Aggregat	GAGP11A	1100x650xh.1345	1,70/89	6.107,00
		GAGP14A	1400x650xh.1345	2,06/112	7.427,00
		GAGP17A	1700x650xh.1345	2,47/135	8.747,00
		GAGP20A	2050x650xh.1345	2,89/158	10.068,00
	Geschlossene Umluft-Kühlvitrine mit Boden und integriertem Aggregat	GAGP11C	1100x650xh.1345	2,06/126	6.224,00
		GAGP14C	1400x650xh.1345	2,06/126	7.582,00
		GAGP17C	1700x650xh.1345	2,89/165	8.940,00
		GAGP20C	2050x650xh.1345	2,89/165	10.299,00
	Umluft-Kühlvitrine mit Klappen, Boden und integriertem Aggregat	GAGP11F	1100x650xh.1345	2,06/124	6.319,00
		GAGP14F	1400x650xh.1345	2,06/124	7.716,00
		GAGP17F	1700x650xh.1345	2,89/162	9.115,00
		GAGP20F	2050x650xh.1345	2,89/162	10.515,00
	Umluft-Kühlvitrine mit Schiebetüren, Boden und integriertem Aggregat	GAGP11P	1100x650xh.1345	2,06/124	6.289,00
		GAGP14P	1400x650xh.1345	2,06/124	7.663,00
		GAGP17P	1700x650xh.1345	2,89/162	9.047,00
		GAGP20P	2050x650xh.1345	2,89/162	10.432,00
	Offene Umluft-Kühlvitrine ohne Boden mit integriertem Aggregat	GAGS11A	1100x630xh.1330	2,06/106	5.863,00
		GAGS14A	1400x630xh.1330	2,06/106	7.066,00
		GAGS17A	1700x630xh.1330	2,89/150	8.316,00
		GAGS20A	2050x630xh.1330	2,89/150	9.563,00
	Geschlossene Umluft-Kühlvitrine ohne Boden, mit integriertem Aggregat	GAGS11C	1100x630xh.1330	2,06/120	5.939,00
		GAGS14C	1400x630xh.1330	2,06/120	7.221,00
		GAGS17C	1700x630xh.1330	2,89/157	8.509,00
		GAGS20C	2050x630xh.1330	2,89/157	9.795,00
	Umluft-Kühlvitrine mit Klappen und integriertem Aggregat, ohne Boden	GAGS11F	1100x630xh.1330	2,06/118	6.039,00
		GAGS14F	1400x630xh.1330	2,06/118	7.356,00
		GAGS17F	1700x630xh.1330	2,89/164	8.683,00
		GAGS20F	2050x630xh.1330	2,89/164	10.012,00
	Umluft-Kühlvitrine mit Schiebetüren und integriertem Aggregat, ohne Boden	GAGS11P	1100x630xh.1330	2,06/118	5.997,00
		GAGS14P	1400x630xh.1330	2,06/118	7.302,00
		GAGS17P	1700x630xh.1330	2,89/164	8.615,00
		GAGS20P	2050x630xh.1330	2,89/164	9.927,00
	Offene Umluft-Kühlvitrine mit Boden, für Zentral-Kühlung	GARP11A	1100x650xh.1015	1,35/79	5.527,00
		GARP14A	1400x650xh.1015	1,66/92	6.787,00
		GARP17A	1700x650xh.1015	1,97/107	8.049,00
		GARP20A	2050x650xh.1015	2,30/123	9.312,00
	Geschlossene Umluft-Kühlvitrine mit Boden, für Zentral-Kühlung	GARP11C	1100x650xh.1015	1,66/106	6.602,00
		GARP14C	1400x650xh.1015	1,66/106	7.582,00
		GARP17C	1700x650xh.1015	2,30/130	8.563,00
		GARP20C	2050x650xh.1015	2,30/130	9.543,00
	Offene Umluft-Kühlvitrine mit Boden, für Zentral-Kühlung	GARP11A	1100x650xh.1015	1,35/79	5.527,00
		GARP14A	1400x650xh.1015	1,66/92	6.787,00
		GARP17A	1700x650xh.1015	1,97/107	7.453,00
		GARP20A	2050x650xh.1015	2,30/123	9.312,00





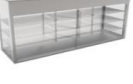
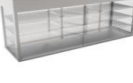
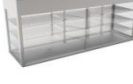











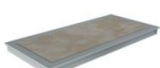







## GALAXY





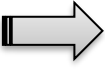

PREISLISTE 2023	Beschreibung	Modelle	Abmessungen		Preis €
	Geschlossene Umluft-Kühlvitrine mit Boden, für Zentral-Kühlung	GARP11C GARP14C GARP17C GARP20C	1100x650xh.1015 1400x650xh.1015 1700x650xh.1015 2050x650xh.1015	1,66/106 1,66/106 2,30/130 2,30/130	6.602,00 7.582,00 8.563,00 9.543,00
	Umluft-Kühlvitrine mit Klappen und Boden, für Zentral-Kühlung	GARP11F GARP14F GARP17F GARP20F	1100x650xh.1015 1400x650xh.1015 1700x650xh.1015 2050x650xh.1015	1,66/104 1,66/104 2,30/127 2,30/127	5.735,00 7.075,00 8.418,00 9.760,00
	Umluft-Kühlvitrine mit Schiebetüren und Boden, für Zentral-Kühlung	GARP11P GARP14P GARP17P GARP20P	1100x650xh.1015 1400x650xh.1015 1700x650xh.1015 2050x650xh.1015	1,66/104 1,66/104 2,30/127 2,30/127	5.682,00 7.021,00 8.349,00 9.676,00
	Offene Umluft-Kühlvitrine ohne Boden, für Zentral-Kühlung	GARS11A GARS14A GARS17A GARS20A	1100x630xh.1000 1400x630xh.1000 1700x630xh.1000 2050x630xh.1000	1,66/86 1,66/86 2,30/115 2,30/115	5.235,00 6.426,00 7.616,00 8.808,00
	Geschlossene Umluft-Kühlvitrine ohne Boden, für Zentral-Kühlung	GARS11C GARS14C GARS17C GARS20C	1100x630xh.1000 1400x630xh.1000 1700x630xh.1000 2050x630xh.1000	1,66/100 1,66/100 2,30/122 2,30/122	5.356,00 6.580,00 7.809,00 9.040,00
	Umluft-Kühlvitrine mit Klappen ohne Boden, für Zentral-Kühlung	GARS11F GARS14F GARS17F GARS20F	1100x630xh.1000 1400x630xh.1000 1700x630xh.1000 2050x630xh.1000	1,66/98 1,66/98 2,30/129 2,30/129	5.467,00 6.714,00 7.968,00 9.221,00
	Umluft-Kühlvitrine mit Schiebetüren ohne Boden, für Zentral-Kühlung	GARS11P GARS14P GARS17P GARS20P	1100x630xh.1000 1400x630xh.1000 1700x630xh.1000 2050x630xh.1000	1,66/98 1,66/98 2,30/129 2,30/129	5.413,00 6.660,00 7.916,00 9.172,00

# GALAXY + ARIES









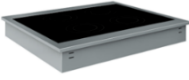

## Beispiele für Zusammenstellungen

GALAXY14 + ARIES 4GN	GAGS14A - GAGS14C - GAGS14F - GAGS14P - GARS14A - GARS14C - GARS14F - GARS14P -		AR4PR1L - AR4PR1LG - AR4PRR - AR4VRSB - AR4VRSA - AR4VRV - AR4VI
GALAXY20 + ARIES 6GN	GAGS20A - GAGS20C - GAGS20F - GAGS20P - GARS20A - GARS20C - GARS20F - GARS20P -		AR6PR1L - AR6PR1LG - AR6PRR - AR6VRSB - AR6VRSA - AR6VRV - AR6VI
  		<p>GAGS14A - GAGS14C - GAGS14F - GAGS14P - GARS14A - GARS13C - GARS13F - GARS13P + AR4PR1L</p> <p>GAGS20A - GAGS20C - GAGS20F - GAGS20P - GARS20A - GARS20C - GARS20F - GARS20P + AR6PR1L</p>	
  		<p>GAGS14A - GAGS14C - GAGS14F - GAGS14P - GARS14A - GARS14C - GARS14F - GARS14P + AR4PR1LG</p> <p>GAGS20A - GAGS20C - GAGS20F - GAGS20P - GARS20A - GARS20C - GARS20F - GARS20P + AR6PR1LG</p>	
  		<p>GAGS14A - GAGS14C - GAGS14F - GAGS14P - GARS14A - GARS14C - GARS14F - GARS14P + AR4PRR</p> <p>GAGS20A - GAGS20C - GAGS20F - GAGS20P - GARS20A - GARS20C - GARS20F - GARS20P + AR6PRR</p>	
  		<p>GAGS14A - GAGS14C - GAGS14F - GAGS14P - GARS14A - GARS14C - GARS14F - GARS14P + AR4VRSB</p> <p>GAGS20A - GAGS20C - GAGS20F - GAGS20P - GARS20A - GARS20C - GARS20F - GARS20P + AR6VRSB</p>	
  		<p>GAGS14A - GAGS14C - GAGS14F - GAGS14P - GARS14A - GARS14C - GARS14F - GARS14P + AR4VRSA</p> <p>GAGS20A - GAGS20C - GAGS20F - GAGS20P - GARS20A - GARS20C - GARS20F - GARS20P + AR6VRSA</p>	
  		<p>GAGS14A - GAGS14C - GAGS14F - GAGS14P - GARS14A - GARS14C - GARS14F - GARS14P + AR4VI</p> <p>GAGS20A - GAGS20C - GAGS20F - GAGS20P - GARS20A - GARS20C - GARS20F - GARS20P + AR6VI</p>	
  		<p>GAGS14A - GAGS14C - GAGS14F - GAGS14P - GARS14A - GARS14C - GARS14F - GARS14P + AR4VRV</p> <p>GAGS20A - GAGS20C - GAGS20F - GAGS20P - GARS20A - GARS20C - GARS20F - GARS20P + <b>AR6VRV</b></p>	
GALAXY20 + ARIES 6GN	GAGS20A - GAGS20C - GAGS20F - GAGS20P - GARS20A - GARS20C - GARS20F - GARS20P -		AR6PR1L - AR6PR1LG - AR6PRR - AR6VRSB - AR6VRSA - AR6VRV - AR6VI



## HYDRA

PREISLISTE 2023	Beschreibung	Modelle		Abmessungen		Preis €
	Kühlplatte aus schwarzem Hartglas mit integriertem Aggregat	HY2GPR1V	2 EN	920x710	0,79/60	2.918,00
		HY3GPR1V	3 EN	1330x710	0,98/65	3.187,00
		HY4GPR1V	4 EN	1740x710	1,20/75	3.606,00
	Kühlplatte aus schwarzem Hartglas, für Zentral-Kühlung	HY2RPR1V	2 EN	920x710	0,69/35	2.259,00
		HY3RPR1V	3 EN	1330x710	0,86/40	2.440,00
		HY4RPR1V	4 EN	1740x710	1,05/45	2.783,00
	Eiscreme-Kühlwanne mit integriertem Aggregat	HY3GVRG	3 EN	770x650	0,70/115	4.694,00
		HY5GVRG	5 EN	1100x650	0,95/130	5.306,00
		HY7GVRG	7 EN	1420x650	1,20/140	6.147,00
		HY9GVRG	9 EN	1745x650	-	7.021,00
		HY11GVRG	11 EN	2070x650	-	7.894,00
	Eiscreme-Wanne, für Zentral-Kühlung	HY3RVRG	3 EN	770x650	0,50/65	4.253,00
		HY5RVRG	5 EN	1100x650	0,65/80	4.843,00
		HY7RVRG	7 EN	1420x650	0,81/95	5.667,00
		HY9RVRG	9 EN	1745x650	-	6.543,00
		HY11RVRG	11 EN	2070x650	-	7.419,00
	Eiscreme-Kühlwanne mit Aufbau und integriertem Aggregat	HY3GVRGS	3 EN	770x650	0,70/115	5.260,00
		HY5GVRGS	5 EN	1100x650	0,95/130	5.997,00
		HY7GVRGS	7 EN	1420x650	1,20/140	6.947,00
		HY9GVRGS	9 EN	1745x650	-	7.939,00
		HY11GVRGS	11 EN	2070x650	-	8.898,00
	Eiscreme-Wanne mit Aufbau, für Zentral-Kühlung	HY3RVRGS	3 EN	770x650	0,50/65	4.825,00
		HY5RVRGS	5 EN	1100x650	0,65/80	5.534,00
		HY7RVRGS	7 EN	1420x650	0,81/95	6.466,00
		HY9RVRGS	9 EN	1745x650	-	7.461,00
		HY11RVRGS	11 EN	2070x650	-	8.423,00

# FORNAX

PREISLISTE 2023	Beschreibung	Modelle	Abmessungen	Preis €
	Infrarot Glaskeramik-Kochplatte	FOPCIF35	350x650	0,03/12 2.181,00
	Infrarot Glaskeramik-Kochplatte	FOPCIF70	700x650	0,06/21 3.635,00
	Induktion Glaskeramik-Kochplatte	FOPCID35	350x650	0,04/20 8.586,00
	Induktion Glaskeramik-Kochplatte	FOPCID40	400x400	4.293,00
	Induktion Glaskeramik-Kochplatte	FOPCID70	700x650	0,08/38 15.741,00
	Induktion Glaskeramik-Wokplatte	FOPCIW40	400x400	0,20/52 4.563,00
	Grillplatte, glatt	FOFTL35	350x650xh.100	0,04/28 1.689,00
	Grillplatte, gerillt	FOFTR35	350x650xh.100	0,04/28 1.759,00
	Grillplatte, verchromt	FOFTC35	350x650xh.100	0,04/28 2.125,00
	Grillplatte, glatt	FOFTL70	700x650xh.100	0,08/53 2.370,00
	Grillplatte, 1/3 gerillt, 2/3 glatt	FOFTLR70	700x650xh.100	0,08/53 2.616,00



# FORNAX

PREISLISTE 2023	Beschreibung	Modelle	Abmessungen		Preis €
	Grillplatte, gerillt	FOFTR70	700x650xh.100	0,08/53	2.722,00
	Grillplatte, verchromt	FOFTC70	700x650xh.100	0,08/53	3.160,00
	Friteuse	FOFG35	350x650xh.50	0,06/16	1.812,00
	Friteuse	FOFG70	700x650xh.50	0,12/30	3.099,00
	Nudelkocher, manuell	FOCPM35	350x650xh.50	0,07/23	2.576,00
	Nudelkocher, automatisch	FOCPA35	350x650xh.50	0,13/30	7.299,00
	Elektrischer Suppentopf 10 L	FOZU10	Ø 325 H. 290	0,25/15	1.752,00



## SHOW PASTA

PREISLISTE 2023	Beschreibung	Modelle	Abmessungen		Preis €
	Gareinheit mit 1 Induktionskochfeld, 1 Nudelkocher und Neutralunterbau	SPNIL10	1000x800xh.900	1,44/105	14.900,00
	Gareinheit mit 1 Wok-Induktionskochfeld, 1 Nudelkocher und Neutralunterbau mit 2 Flügel-Türen	SPNIW10	1000x800xh.900	1,44/105	15.593,00
	Gareinheit mit 1 Infrarotplatte, 1 Nudelkocher und Neutralunterbau mit 2 Flügel-Türen	SPNIR10	1000x800xh.900	1,44/105	13.182,00
	Gareinheit mit 2 Induktionskochfelder, 1 Kühlbecken, 1 Nudelkocher und Tiefkühlunterbau mit 2 großen Schubladen	SPCIL13	1300x800xh.900	1,80/190	25.353,00
	Gareinheit mit 2 Induktionskochfelder, 1 Kühlbecken, 1 Nudelkocher und Kühlunterbau mit 2 großen Schubladen	SPRIL13	1300x800xh.900	1,80/185	23.809,00
	Gareinheit mit 2 Induktionskochfelder (1 glatte Platte und 1 wok), 1 Kühlbecken, 1 Nudelkocher und Tiefkühlunterbau mit 2 großen Schubladen	SPCIW13	1300x800xh.900	1,80/190	27.189,00
	Gareinheit mit 2 Induktionskochfelder (1 glatte Platte und 1 wok), 1 Kühlbecken, 1 Nudelkocher und Kühlunterbau mit 2 großen Schubladen	SPRIW13	1300x800xh.900	1,80/185	24.556,00
	Gareinheit mit 2 Induktionskochfelder, 1 Kühlbecken, 2 Nudelkocher und Tief- Kühlunterbau mit 3 großen Schubladen	SPCIL17	1700x800xh.900	2,30/240	31.928,00

## SHOW PASTA

PREISLISTE 2023	Beschreibung	Modelle	Abmessungen		Preis €
	Gareinheit mit 2 Induktionskochfelder, 1 Kühlbecken, 2 Nudelkocher und Kühl- Unterbau mit 3 großen Schubladen	SPRI17	1700x800xh.900	2,30/235	30.223,00
	Gareinheit mit 2 Induktionskochfelder (1 glatte Platte und 1 wok), 1 Kühlbecken, 2 Nudelkocher und Tiefkühlunterbau mit 3 großen Schubladen	SPCIW17	1700x800xh.900	2,30/240	32.641,00
	Gareinheit mit 2 Induktionskochfelder (1 glatte Platte und 1 wok), 1 Kühlbecken, 2 Nudelkocher und Kühlunterbau mit 3 großen Schubladen	SPRIW17	1700x800xh.900	2,30/235	31.000,00



**CORONA**

PREISLISTE 2023	Beschreibung	Modelle	Abmessungen		Preis €
	Gekühlter Zubereitungstisch	COTPA144	1400x700xh.1200	1,20/168	6.885,00
	Gekühlter Zubereitungstisch	COTPA185	1800x700xh.1200	1,60/193	8.190,00







# TAURUS

PREISLISTE 2023	Beschreibung	Modelle	Abmessungen		Preis €
	Umluft-Kühlbuffet mit integriertem Aggregat	TA2GVRV	1400x1300x925/1405	3,5/150	12.169,00
	Umluft-Kühlbuffet mit integriertem Aggregat	TA4GVRV	2100x1300x925/1405	4,9/180	14.919,00
	Umluft-Kühlbuffet mit integriertem Aggregat	TA6GVRV	2800x1300x925/1405	6,5/220	20.030,00
	Umluft-Kühlbuffet mit integriertem Aggregat	TA8GVRV	3500x1300x925/1405	8,1/260	22.340,00
	Umluft-Kühlbuffet, für Zentral-Kühlung	TA2RVRV	1400x1300x925/1405	3,5/135	11.445,00
	Umluft-Kühlbuffet, für Zentral-Kühlung	TA4RVRV	2100x1300x925/1405	4,9/160	15.877,00
	Umluft-Kühlbuffet, für Zentral-Kühlung	TA6RVRV	2800x1300x925/1405	6,5/190	18.630,00
	Umluft-Kühlbuffet, für Zentral-Kühlung	TA8RVRV	3500x1300x925/1405	8,1/230	20.887,00

PREISLISTE 2023	Beschreibung	Modelle	Abmessungen		Preis €
	Umluft-Kühlbuffet mit integriertem Aggregat	OR80GVRV	800x1000xh.1260		6.342,00
		OR115GVRV	1150x1000xh.1260		8.661,00
		OR150GVRV	1500x1000xh.1260		10.177,00
		OR185GVRV	1850x1000xh.1260		12.095,00
		OR225GVRV	2250x1000xh.1260		14.010,00
	Umluft-Kühlbuffet, für Zentral-Kühlung	OR80VRV	800x1000xh.1260		5.870,00
		OR115VRV	1150x1000xh.1260		7.793,00
		OR150VRV	1500x1000xh.1260		9.352,00
		OR185VRV	1850x1000xh.1260		11.218,00
		OR225VRV	2250x1000xh.1260		13.870,00
	Befeuchtetes Warmbuffet	OR80CU	800x1000xh.1260		6.262,00
		OR115CU	1150x1000xh.1260		8.021,00
		OR150CU	1500x1000xh.1260		9.811,00
		OR185CU	1850x1000xh.1260		11.600,00
		OR230CU	2250x1000xh.1260		13.382,00

# HYDRA

LISTINO TARIF PREISLISTE PRICE LIST 2015	Descrizione	Modello	EN	Dimensioni	m <sup>3</sup> /kg	Prezzo €
	Désignation	Modèle		Dimensions		
	Beschreibung	Modell		Abmessungen		
	Description	Model		Dimensions		
	Piano refrigerato in vetro temperato con gruppo	HY2GPR1V	2	920x710xh.15	0,79/60	2.549,00
	Plan réfrigéré en verre trempé avec groupe logé	HY3GPR1V	3	1330x710xh.15	0,98/65	2.784,00
	Kühlplatte aus Hartglas mit integriertem Aggregat	HY4GPR1V	4	1740x710xh.15	1,20/75	3.150,00
	Refrigerated top in toughened glass, with integrated unit					
	Piano refrigerato in vetro temperato, gruppo remoto	HY2RPR2V	2	920x710xh.15	0,69/35	1.974,00
	Plan réfrigéré en verre trempé, groupe à distance	HY3RPR2V	3	1330x710xh.15	0,86/40	2.131,00
	Kühlplatte aus Hartglas, für Zentral-Kühlung	HY4RPR2V	4	1740x710xh.15	1,05/45	2.431,00
	Refrigerated top in toughened glass, for remote unit					
LISTINO TARIF PREISLISTE PRICE LIST 2015	Descrizione	Modello	Vaschette	Dimensioni	m <sup>3</sup> /kg	Prezzo €
	Désignation	Modèle	Bacs	Dimensions		
	Beschreibung	Modell	Behälter	Abmessungen		
	Description	Model	Basins	Dimensions		
	Vasca gelato con gruppo	HY3GVRG	3	770x650xh.15	0,70/115	4.100,00
	Cuve à glace avec groupe logé	HY5GVRG	5	1100x650xh.15	0,95/130	4.635,00
	Eiscreme-Kühlwanne mit integriertem Aggregat	HY7GVRG	7	1420x650xh.15	1,20/140	5.370,00
	Ice-cream well with integrated unit					
	Vasca gelato, gruppo remoto	HY3RVRG	3	770x650xh.15	0,50/65	3.715,00
	Cuve à glace, groupe à distance	HY5RVRG	5	1100x650xh.15	0,65/80	4.230,00
	Eiscreme-Wanne, für Zentral-Kühlung	HY7RVRG	7	1420x650xh.15	0,81/95	4.950,00
	Ice-cream well, for remote unit					



# FORNAX

<b>LISTINO TARIF PREISLISTE PRICE LIST 2015</b>	<b>Descrizione Description Beschreibung Description</b>	<b>Modello Modèle Modell Model</b>	<b>Dimensioni Dimensions Abmessungen Dimensions</b>	<b>m<sup>3</sup>/kg</b>	<b>Prezzo € Prix € Preis € Price €</b>
	Piano di cottura vetroceramica ad infrarossi Plan de cuisson vitrocéramique à infrarouges Infrarot Glaskeramik-Kochplatte Infrared ceramic glass cooktop	FOPCIF35	350x650xh.15	0,03/12	1.905,00
	Piano di cottura vetroceramica ad infrarossi Plan de cuisson vitrocéramique à infrarouges Infrarot Glaskeramik-Kochplatte Infrared ceramic glass cooktop	FOPCIF70	700x650xh.15	0,06/21	3.175,00
	Piano di cottura vetroceramica ad induzione Plan de cuisson vitrocéramique à induction Induktion Glaskeramik-Kochplatte Induction ceramic glass cooktop	FOPCID35	350x650xh.15	0,04/20	7.500,00
	Piano di cottura vetroceramica ad induzione Plan de cuisson vitrocéramique à induction Induktion Glaskeramik-Kochplatte Induction ceramic glass cooktop	FOPCID70	700x650xh.15	0,08/38	13.750,00
	Piano di cottura vetroceramica wok ad induzione Plan de cuisson vitrocéramique wok à induction Induktion Glaskeramik-Wokplatte Induction ceramic glass wok top	FOPCIW40	400x400xh.15	0,20/52	3.986,00
	Fry top piastra liscia Grillade plaque lisse Grillplatte, glatt Griddle, smooth plate	FOFTL35	350x650xh.100	0,04/28	1.475,00
	Fry top piastra rigata Grillade plaque nervurée Grillplatte, gerillt Griddle, grooved plate	FOFTR35	350x650xh.100	0,04/28	1.537,00
	Fry top piastra cromata Grillade plaque chromée Grillplatte, verchromt Griddle, chrome plate	FOFTC35	350x650xh.100	0,04/28	1.857,00
	Fry top piastra liscia Grillade plaque lisse Grillplatte, glatt Griddle, smooth plate	FOFTL70	700x650xh.100	0,08/53	2.070,00
	Fry top piastra 1/3 rigata, 2/3 liscia Grillade plaque 1/3 nervurée, 2/3 lisse Grillplatte, 1/3 gerillt, 2/3 glatt Griddle, 1/3 grooved, 2/3 smooth	FOFTLR70	700x650xh.100	0,08/53	2.285,00

# FORNAX

<b>LISTINO TARIF PREISLISTE PRICE LIST 2015</b>	<b>Descrizione Description Beschreibung Description</b>	<b>Modello Modèle Modell Model</b>	<b>Dimensioni Dimensions Abmessungen Dimensions</b>	<b>m<sup>3</sup>/kg</b>	<b>Prezzo € Prix € Preis € Price €</b>
	Fry top piastra rigata Grillade plaque nervurée Grillplatte, gerillt Griddle, grooved plate	FOFTR70	700x650xh.100	0,08/53	2.377,00
	Fry top piastra cromata Grillade plaque chromée Grillplatte, verchromt Griddle, chrome plate	FOFTC70	700x650xh.100	0,08/53	2.760,00
	Friggitrice Friteuse Friteuse Deep fryer	FOFG35	350x650xh.50	0,06/16	1.583,00
	Friggitrice Friteuse Friteuse Deep fryer	FOFG70	700x650xh.50	0,12/30	2.707,00
	Brasiera Sauteuse Bratpfanne Bratt pan	FOBR35	350x650xh.45	0,04/21	1.670,00
	Cuocipasta, manuale Cuiseur à pâtes, manuel Nudelkocher, manuell Pasta cooker, manual	FOCPM35	350x650xh.50	0,07/23	2.250,00
	Cuocipasta, automatico Cuiseur à pâtes, automatique Nudelkocher, automatisch Pasta cooker, automatic	FOCPA35	350x650xh.50	0,13/30	6.375,00
	Scaldapatate Chauffe-frites Pommes Frites Wärmer Chip warmer	FOSP35	350x650xh.170	0,06/13	1.457,00
	Zuppiera elettrica 10 L Soupière électrique 10 L Elektrischer Suppentopf 10 L Electric soup kettle 10 L	FOZU10	430x650xh.15mm	0,25/15	1.530,00
	Zuppiera elettrica 20 L Soupière électrique 20 L Elektrischer Suppentopf 20 L Electric soup kettle 20 L	FOZU20	430x650xh.15mm	0,40/23	2.083,00

# FORNAX

<b>LISTINO TARIF PREISLISTE PRICE LIST 2015</b>	<b>Descrizione Description Beschreibung Description</b>	<b>Modello Modèle Modell Model</b>	<b>Dimensioni Dimensions Abmessungen Dimensions</b>	<b>m<sup>3</sup>/kg</b>	<b>Prezzo € Prix € Preis € Price €</b>
	Piano di cottura elettrico Table de cuisson électrique Elektrisches Kochfeld Electric cooktop	FOPCEG35	350x650xh.15	0,06/11	1.180,00
	Lavello Plonge Spülbecken Sink	FOLV35	350x650xh.140	0,06/12	975,00

**ACCESSORI  
ACCESSOIRES  
ZUBEHÖR  
ACCESSORIES**

LISTINO TARIF PREISLISTE PRICE LIST 2015	Descrizione Désignation Beschreibung Description	Modello Modèle Modell Model	Rif. apparecchiature Appareils de référence Gerätebezeichnung Appliance reference	GN	Prezzo € Prix € Preis € Price €
	Bacinella d'evaporazione Bac d'évaporation Tauwasserverdunstungsschale Condensate-evaporating tray	DABE	-	-	220,00
	Tendina termica 2 GN Rideau thermique 2 GN Nachttrollo 2 GN Thermic front blind 2 GN	DATT2	VIRGO - LYRA - GEMINI - VELA - PEGASUS	2	220,00
	Tendina termica 3 GN Rideau thermique 3 GN Nachttrollo 3 GN Thermic front blind 3 GN	DATT3	VIRGO - LYRA - GEMINI - VELA - PEGASUS	3	245,00
	Tendina termica 4 GN Rideau thermique 4 GN Nachttrollo 4 GN Thermic front blind 4 GN	DATT4	VIRGO - LYRA - GEMINI - VELA - PEGASUS	4	260,00
	Tendina termica 5 GN Rideau thermique 5 GN Nachttrollo 5 GN Thermic front blind 5 GN	DATT5	VIRGO - LYRA - GEMINI - VELA - PEGASUS	5	295,00
	Tendina termica 6 GN Rideau thermique 6 GN Nachttrollo 6 GN Thermic front blind 6 GN	DATT6	PEGASUS	6	480,00
	Sonda cuore Sonde à piquer Kerntemperaturfühler Core probe	DASQ	GEMINI - PEGASUS	-	260,00
	Piano d'appoggio in granito GN 1/1 Plateau en granit GN 1/1 Granitplatte GN 1/1 Granite top GN 1/1	DAPG1	GEMINI - VELA	-	240,00
	Piano d'appoggio in acciaio inox GN 1/1 Plateau en acier inox GN 1/1 Edelstahlplatte GN 1/1 Stainless steel top GN 1/1	DAP11	GEMINI - VELA	-	65,00
	Piano d'appoggio in granito GN 1/1+1/3 Plateau en granit GN 1/1 + 1/3 Granitplatte GN 1/1 + 1/3 Granite top GN 1/1 + 1/3	DAPG2	PEGASUS	-	290,00

**ACCESSORI  
ACCESSOIRES  
ZUBEHÖR  
ACCESSORIES**

LISTINO TARIF PREISLISTE PRICE LIST 2015	Descrizione Désignation Beschreibung Description	Modello Modèle Modell Model	Rif. apparecchiature Appareils de référence Gerätebezugnahme Appliance reference	GN	Prezzo € Prix € Preis € Price €
	Piano d'appoggio in acciaio inox GN 1/1+1/3 Plateau en acier inox GN 1/1 + 1/3 Edelstahlplatte GN 1/1 + 1/3 Stainless steel top GN 1/1 + 1/3	DAPI2	PEGASUS	-	90,00
	Vetro frontale parasputo 2 GN Verre frontal pare-haleine 2 GN Frontscheibe 2 GN Front glass sneeze guard 2 GN	DAVF2	LIBRA	2	140,00
	Vetro frontale parasputo 3 GN Verre frontal pare-haleine 3 GN Frontscheibe 3 GN Front glass sneeze guard 3 GN	DAVF3	LIBRA	3	150,00
	Vetro frontale parasputo 4 GN Verre frontal pare-haleine 4 GN Frontscheibe 4 GN Front glass sneeze guard 4 GN	DAVF4	LIBRA	4	170,00
	Vetro frontale parasputo 5 GN Verre frontal pare-haleine 5 GN Frontscheibe 5 GN Front glass sneeze guard 5 GN	DAVF5	LIBRA	5	190,00
	Vetro frontale parasputo 6 GN Verre frontal pare-haleine 6 GN Frontscheibe 6 GN Front glass sneeze guard 6 GN	DAVF6	LIBRA	6	210,00
	Falsofondo forato 1 GN Faux fond perforé 1 GN Gelochter Blindboden 1 GN Perforated false bottom shelf 1 GN	DAFF1	ARIES	1	100,00
	Falsofondo forato 2 GN Faux fond perforé 2 GN Gelochter Blindboden 2 GN Perforated false bottom shelf 2 GN	DAFF2	ARIES - LIBRA	2	125,00
	Falsofondo forato 3 GN Faux fond perforé 3 GN Gelochter Blindboden 3 GN Perforated false bottom shelf 3 GN	DAFF3	ARIES - LIBRA	3	150,00
	Falsofondo forato 4 GN Faux fond perforé 4 GN Gelochter Blindboden 4 GN Perforated false bottom shelf 4 GN	DAFF4	ARIES - LIBRA	4	175,00











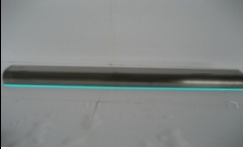

**ACCESSORI  
ACCESSOIRES  
ZUBEHÖR  
ACCESSORIES**

LISTINO TARIF PREISLISTE PRICE LIST 2015	Descrizione Désignation Beschreibung Description	Modello Modèle Modell Model	Rif. apparecchiature Appareils de référence Gerätebezugnahme Appliance reference	GN	Prezzo € Prix € Preis € Price €
	Falsobondo forato 5 GN Faux fond perforé 5 GN Gelochter Blindboden 5 GN Perforated false bottom shelf 5 GN	DAFF5	ARIES - LIBRA	5	200,00
	Falsobondo forato 6 GN Faux fond perforé 6 GN Gelochter Blindboden 6 GN Perforated false bottom shelf 6 GN	DAFF6	ARIES - LIBRA	6	225,00
	Ripiano intermedio Gemini 2 GN Étagère intermédiaire Gemini 2 GN Einlegeboden Gemini 2 GN Intermediate shelf Gemini 2 GN	DAGER2	GEMINI	2	155,00
	Ripiano intermedio Gemini 3 GN Étagère intermédiaire Gemini 3 GN Einlegeboden Gemini 3 GN Intermediate shelf Gemini 3 GN	DAGER3	GEMINI - PEGASUS	3	170,00
	Ripiano intermedio Gemini 4 GN Étagère intermédiaire Gemini 4 GN Einlegeboden Gemini 4 GN Intermediate shelf Gemini 4 GN	DAGER4	GEMINI - PEGASUS	4	185,00
	Ripiano intermedio Gemini 5 GN Étagère intermédiaire Gemini 5 GN Einlegeboden Gemini 5 GN Intermediate shelf Gemini 5 GN	DAGER5	GEMINI - PEGASUS	5	200,00
	Ripiano intermedio Pegasus 6 GN Étagère intermédiaire Pegasus 6 GN Einlegeboden Pegasus 6 GN Intermediate shelf Pegasus 6 GN	DAGER6	PEGASUS	6	310,00
	Unità condensatrice Unité de condensation Kühlaggregat Condensing unit	DAUC1	ARIES - LIBRA (2 - 3 GN)	-	695,00
	Unità condensatrice Unité de condensation Kühlaggregat Condensing unit	DAUC2	PEGASUS (2 GN) ARIES - LIBRA ( 4 - 5 GN)	-	780,00
	Unità condensatrice Unité de condensation Kühlaggregat Condensing unit	DAUC3	PEGASUS (3 GN) ARIES - LIBRA (6 GN)	-	890,00







**ACCESSORI  
ACCESSOIRES  
ZUBEHÖR  
ACCESSORIES**

LISTINO TARIF PREISLISTE PRICE LIST 2015	Descrizione Désignation Beschreibung Description	Modello Modèle Modell Model	Rif. apparecchiature Appareils de référence Gerätebezugsname Appliance reference	GN	Prezzo € Prix € Preis € Price €
	Unità condensatrice Unité de condensation Kühlaggregat Condensing unit	DAUC4	GEMINI - VELA (2 GN) PEGASUS (4 - 5 GN)	-	1.050,00
	Unità condensatrice Unité de condensation Kühlaggregat Condensing unit	DAUC5	GEMINI - VELA (3 GN) PEGASUS (6 GN)	-	1.200,00
	Unità condensatrice Unité de condensation Kühlaggregat Condensing unit	DAUC6	GEMINI - VELA (4 GN)	-	1.450,00
	Unità condensatrice Unité de condensation Kühlaggregat Condensing unit	DAUC7	GEMINI - VELA (5 GN)	-	1.620,00
	Sovrastuttura neutra 2 GN Superstructure neutre 2 GN Neutralaufbau 2 GN Neutral superstructure 2 GN	DASN2	-	2	450,00
	Sovrastuttura neutra 3 GN Superstructure neutre 3 GN Neutralaufbau 3 GN Neutral superstructure 3 GN	DASN3	-	3	490,00
	Sovrastuttura neutra 4 GN Superstructure neutre 4 GN Neutralaufbau 4 GN Neutral superstructure 4 GN	DASN4	-	4	540,00
	Sovrastuttura neutra 5 GN Superstructure neutre 5 GN Neutralaufbau 5 GN Neutral superstructure 5 GN	DASN5	-	5	570,00
	Sovrastuttura neutra 6 GN Superstructure neutre 6 GN Neutralaufbau 6 GN Neutral superstructure 6 GN	DASN6	-	6	620,00
	Illuminazione con lampada fluorescente 2 GN Éclairage par lampe fluorescente 2 GN Beleuchtung durch Leuchtstofflampe 2 GN Lighting with fluorescent lamp 2 GN	DAIF2	-	2	290,00

**ACCESSORI  
ACCESSOIRES  
ZUBEHÖR  
ACCESSORIES**

LISTINO TARIF PREISLISTE PRICE LIST 2015	Descrizione Désignation Beschreibung Description	Modello Modèle Modell Model	Rif. apparecchiature Appareils de référence Gerätebezugsnahme Appliance reference	GN	Prezzo € Prix € Preis € Price €
	<p>illuminazione con lampada fluorescente 3 GN Éclairage par lampe fluorescente 3 GN Beleuchtung durch Leuchtstofflampe 3 GN Lighting with fluorescent lamp 3 GN</p>	DAIF3	-	3	340,00
	<p>illuminazione con lampada fluorescente 4 GN Éclairage par lampe fluorescente 4 GN Beleuchtung durch Leuchtstofflampe 4 GN Lighting with fluorescent lamp 4 GN</p>	DAIF4	-	4	380,00
	<p>illuminazione con lampada fluorescente 5 GN Éclairage par lampe fluorescente 5 GN Beleuchtung durch Leuchtstofflampe 5 GN Lighting with fluorescent lamp 5 GN</p>	DAIF5	-	5	430,00
	<p>illuminazione con lampada fluorescente 6 GN Éclairage par lampe fluorescente 6 GN Beleuchtung durch Leuchtstofflampe 6 GN Lighting with fluorescent lamp 6 GN</p>	DAIF6	-	6	480,00
	<p>illuminazione e riscaldamento 2 GN Rampe d'éclairage et chauffage 2 GN Beleuchtung und Beheizung 2 GN Lighting and heating lamps 2 GN</p>	DAIR2	-	2	390,00
	<p>illuminazione e riscaldamento 3 GN Rampe d'éclairage et chauffage 3 GN Beleuchtung und Beheizung 3 GN Lighting and heating lamps 3 GN</p>	DAIR3	-	3	430,00
	<p>illuminazione e riscaldamento 4 GN Rampe d'éclairage et chauffage 4 GN Beleuchtung und Beheizung 4 GN Lighting and heating lamps 4 GN</p>	DAIR4	-	4	450,00
	<p>illuminazione e riscaldamento 5 GN Rampe d'éclairage et chauffage 5 GN Beleuchtung und Beheizung 5 GN Lighting and heating lamps 5 GN</p>	DAIR5	-	5	470,00
	<p>illuminazione e riscaldamento 6 GN Rampe d'éclairage et chauffage 6 GN Beleuchtung und Beheizung 6 GN Lighting and heating lamps 6 GN</p>	DAIR6	-	6	510,00
	<p>Struttura con vetro frontale parasputo 2 GN Structure verre frontal pare-haleine 2 GN Struktur mit Frontscheibe 2 GN Structure with front glass sneeze guard 2GN</p>	DASVF2	-	2	445,00







**ACCESSORI  
ACCESSOIRES  
ZUBEHÖR  
ACCESSORIES**

LISTINO TARIF PREISLISTE PRICE LIST 2015	Descrizione Désignation Beschreibung Description	Modello Modèle Modell Model	Rif. apparecchiature Appareils de référence Gerätebezugsname Appliance reference	GN	Prezzo € Prix € Preis € Price €
	Struttura vetro frontale 3 GN Structure verre frontal pare-haleine 3 GN Struktur mit Frontscheibe 3 GN Structure with front glass sneeze guard 3GN	DASVF3		3	475,00
	Struttura con vetro frontale 4 GN Structure verre frontal pare-haleine 4 GN Struktur mit Frontscheibe 4 GN Structure with front glass sneeze guard 4GN	DASVF4	-	4	510,00
	Struttura con vetro frontale 5 GN Structure verre frontal pare-haleine 5 GN Struktur mit Frontscheibe 5 GN Structure with front glass sneeze guard 5GN	DASVF5	-	5	540,00
	Struttura con vetro frontale 6 GN Structure verre frontal pare-haleine 6 GN Struktur mit Frontscheibe 6 GN Structure with front glass sneeze guard 6GN	DASVF6	-	6	575,00
	Kit 4 ruote (2 con freno) Kit 4 roues (dont 2 avec frein ) Set mit 4 Rollen (2 mit Bremse) Kit of 4 castors (2 with brakes)	DAKR1	SP10 - SP13 - SP17	-	275,00
	Kit 2 cestelli piccoli con supporto Kit 2 petits paniers avec support Set mit 2 kleinen Körben mit Halterung Kit of 2 small baskets with support	DACP	SP10 - SP13 - SP17	-	209,00
	Kit 2 cestelli grandi con supporto Kit 2 grands paniers avec support Set mit 2 großen Körben mit Halterung Kit of 2 large baskets with support	DACG	SP10 - SP13 - SP17	-	239,00
	Sovrastruttura con supporto padella SP10 Superstructure avec support poêle SP10 Hartglas-Aufbau mit Pfannhalterung SP10 Superstructure with fry pan support SP10	DASV10	SP10	-	503,00
	Sovrastruttura con supporto padella SP13 Superstructure avec support poêle SP13 Hartglas-Aufbau mit Pfannhalterung SP13 Superstructure with fry pan support SP13	DASV13	SP13	-	691,00
	Sovrastruttura con supporto padella SP17 Superstructure avec support poêle SP17 Hartglas-Aufbau mit Pfannhalterung SP17 Superstructure with fry pan support SP17	DASV17	SP17	-	873,00

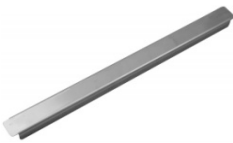
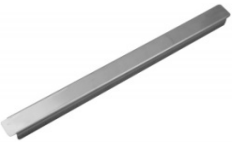
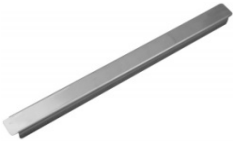
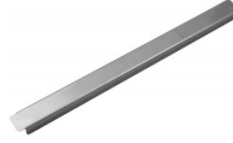

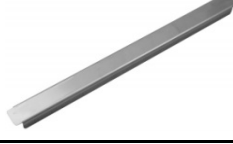

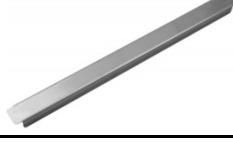
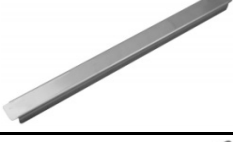



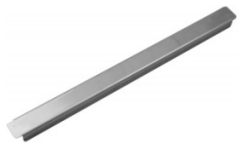

**ACCESSORI  
ACCESSOIRES  
ZUBEHÖR  
ACCESSORIES**

LISTINO TARIF PREISLISTE PRICE LIST 2015	Descrizione Désignation Beschreibung Description	Modello Modèle Modell Model	Rif. apparecchiature Appareils de référence Gerätebezeichnung Appliance reference	GN	Prezzo € Prix € Preis € Price €
	Kit 4 ruote (2 con freno) per strutture Kit 4 roues (dont 2 avec frein) pour structures Set mit 4 Rollen (2 mit Bremse) für Rohrgestelle Kit of 4 castors (2 with brakes) for frames	EKR	Strutture Structures Rohrgestelle Frames	-	275,00
	Coperchio sollevatore piatti Ø 260 Couvercle pour distributeur à assiettes Ø 260 Deckel für Tellerspender Ø 260 Lid for plate dispenser Ø 260	DAC26	ARSN26 - ARSC26 - ARSND26 ARSCD26	-	225,00
	Coperchio sollevatore piatti Ø 310 Couvercle distributeur à assiettes Ø 310 Deckel für Tellerspender Ø 310 Lid for plate dispenser Ø 310	DAC31	ARSN31 - ARSC31 - ARSND31 ARSCD31	-	237,00
	Coperchio sollevatore cestelli Couvercle pour distributeur à casiers Deckel für Korbspender Lid for basket dispenser	DAC3CT	ARSNC - ARSCC	-	213,00
	Coperchio brasiera Couvercle pour sauteuse Deckel für Bratpfanne Lid for bratt pan	DACPB	FOBR35	-	50,00
	Coppia cesti friggitrice Jeu de 2 paniers pour friteuse 2 Körbe für Friteuse Pair of baskets for fryer	DACF	FOFG35 - FOFG70	-	114,00
	Raschietto per fry top Racloir pour grillade Schaber für Grillplate Scraper for griddle	DARAS	FOFTL35 - FOFTR35 - FOFTC35 FOFTL70 - FOFTR70 - FOFTC70 FOFTR70	-	48,00
	Kit lame di ricambio (10 pz) Kit lames de rechange (10 pcs) Set Ersatzklingen (10 St.) Spare blades kit (10 pcs)	DALAM	FOFTL35 - FOFTR35 - FOFTC35 FOFTL70 - FOFTR70 - FOFTC70 FOFTR70	-	32,00
	Lavaporzionatore con rubinetto. Dim. 380x165xh.15 mm. Dim. Foratura: 360x145 mm. H2O in.:1/2" - H2O out:3/4". Rince-cuillère à glace avec robinet. Dim. 380x165xh.15 mm. Dim. découpe 360x145 mm. H2O In.:1/2" - H2O out:3/4" . Eisportionierspüler mit Hahn. Abmessungen: 380x165xh.15 mm. Abm. Öffnung: 360x145 mm. H2O in.:1/2" - H2O out:3/4". Ice-cream scoop washer with tap. Dim. 380x165xh.15 mm. Hole size: 360x145 mm. H2O in.:1/2" - H2O out:3/4".	DALAPZ	-	-	496,00











**ACCESSORI  
ACCESSOIRES  
ZUBEHÖR  
ACCESSORIES**

LISTINO TARIF PREISLISTE PRICE LIST 2015	Descrizione Désignation Beschreibung Description	Modello Modèle Modell Model	Rif. apparecchiature Appareils de référence Gerätebezugsname Appliance reference	GN	Prezzo € Prix € Preis € Price €
	Supporto per bacinelle GN 1/1 Support pour bacs GN 1/1 Halterung für Behälter GN 1/1 Support for containers GN 1/1	DAT1	ARIES - LIBRA - VELA - GEMINI	-	13,50
	Supporto per bacinelle GN 1/2 Support pour bacs GN 1/2 Halterung für Behälter GN 1/2 Support for containers GN 1/2	DAT2	ARIES - LIBRA - VELA - GEMINI	-	9,00
	Kit supporti bacinelle GN per vasche refrigerate ventilate 2 GN Paire de supports bacs GN pour cuves réfrigérées ventilées 2 GN Paar Halterungen für GN-Behälter für Umluft-Kühlbecken 2 GN Pair of supports for GN containers for ventilated refrigerated well 2 GN	DASBVRV2	GEMINI	2	180,00
	Kit supporti bacinelle GN per vasche refrigerate ventilate 3 GN Paire de supports bacs GN pour cuves réfrigérées ventilées 3 GN Paar Halterungen für GN-Behälter für Umluft-Kühlbecken 3 GN Pair of supports for GN containers for ventilated refrigerated well 3 GN	DASBVRV3	GEMINI	3	197,00
	Kit supporti bacinelle GN per vasche refrigerate ventilate 4 GN Paire de supports bacs GN pour cuves réfrigérées ventilées 4 GN Paar Halterungen für GN-Behälter für Umluft-Kühlbecken 4 GN Pair of supports for GN containers for ventilated refrigerated well 4 GN	DASBVRV4	GEMINI	4	212,00
	Kit supporti bacinelle GN per vasche refrigerate ventilate 5 GN Paire de supports bacs GN pour cuves réfrigérées ventilées 5 GN Paar Halterungen für GN-Behälter für Umluft-Kühlbecken 5 GN Pair of supports for GN containers for ventilated refrigerated well 5 GN	DASBVRV5	GEMINI	5	237,00
	Kit supporti bacinelle GN per vasche refrigerate ventilate 6 GN Paire de supports bacs GN pour cuves réfrigérées ventilées 6 GN Paar Halterungen für GN-Behälter für Umluft-Kühlbecken 5 GN Pair of supports for GN containers for ventilated refrigerated well 6 GN	DASBVRV6	GEMINI	6	249,00
	Kit supporti bacinelle GN per vetrine 2 GN Paire de supports bacs GN pour vitrines 2 GN Paar Halterungen für GN-Behälter für Vitrinen 2 GN Pair of supports for GN containers for displays 2 GN	DASBV2	GEMINI - VELA	2	180,00
	Kit supporti bacinelle GN per vetrine 3 GN Paire de supports bacs GN pour vitrines 3 GN Paar Halterungen für GN-Behälter für Vitrinen 3 GN Pair of supports for GN containers for displays 3 GN	DASBV3	GEMINI - VELA	3	197,00
	Kit supporti bacinelle GN per vetrine 4 GN Paire de supports bacs GN pour vitrines 4 GN Paar Halterungen für GN-Behälter für Vitrinen 4 GN Pair of supports for GN containers for displays 4 GN	DASBV4	GEMINI - VELA	4	212,00

**ACCESSORI  
ACCESSOIRES  
ZUBEHÖR  
ACCESSORIES**





LISTINO TARIF PREISLISTE PRICE LIST 2015	Descrizione Désignation Beschreibung Description	Modello Modèle Modell Model	Rif. apparecchiature Appareils de référence Gerätebezugsname Appliance reference	GN	Prezzo € Prix € Preis € Price €
	Kit supporti bacinelle GN per vetrine 5 GN Paire de supports bacs GN pour vitrines 5 GN Paar Halterungen für GN-Behälter für Vitrinen 5 GN Pair of supports for GN containers for displays 5 GN	DASBV5	GEMINI - VELA	5	237,00
	Illuminazione a led per vetrina su ogni ripiano 2 GN Éclairage à led sous chaque étagère de vitrine 2 GN Led-Beleuchtung unter jedem Einlegeboden auf Vitrinen 2 GN LED lighting under each display shelf 2 GN	DAILV2	GEMINI - VELA - VIRGO - LYRA	2	474,00
	Illuminazione a led per vetrina su ogni ripiano 3 GN Éclairage à led sous chaque étagère de vitrine 3 GN Led-Beleuchtung unter jedem Einlegeboden auf Vitrinen 3 GN LED lighting under each display shelf 3 GN	DAILV3	GEMINI - VELA - VIRGO - LYRA	3	597,00
	Illuminazione a led per vetrina su ogni ripiano 4 GN Éclairage à led sous chaque étagère de vitrine 4 GN Led-Beleuchtung unter jedem Einlegeboden auf Vitrinen 4 GN LED lighting under each display shelf 4 GN	DAILV4	GEMINI - VELA - VIRGO - LYRA	4	720,00
	Illuminazione a led per vetrina su ogni ripiano 5 GN Éclairage à led sous chaque étagère de vitrine 5 GN Led-Beleuchtung unter jedem Einlegeboden auf Vitrinen 5 GN LED lighting under each display shelf 5 GN	DAILV5	GEMINI - VELA - VIRGO - LYRA	5	843,00
	Bacinella GN 1/1 h. 200 mm Bac GN 1/1 h. 200 mm GN-Behälter 1/1 H. 200 mm GN container 1/1 h. 200 mm	DABG120	ARIES - LIBRA	1/1 h.200	108,10
	Bacinella GN 1/1 h. 100 mm Bac GN 1/1 h. 100 mm GN-Behälter 1/1 H. 100 mm GN container 1/1 h. 100 mm	DABG110	ARIES - LIBRA - GEMINI - VELA	1/1 h.100	79,80
	Bacinella GN 1/1 h. 20 mm Bac GN 1/1 h. 20 mm GN-Behälter 1/1 H. 20 mm GN container 1/1 h. 20 mm	DAB1G12	ARIES - LIBRA - GEMINI - VELA	1/1 h.20	45,50
	Bacinella GN 1/4 h. 150 mm Bac GN 1/4 h. 150 mm GN-Behälter 1/4 H. 150 mm GN container 1/4 h. 150 mm	DABG1415	CORONA	1/4 h.150	33,10
	Vaschetta gelato 360x165xh.180 mm Bac à glace 360x165xh.180 mm Behälter für Eiscreme 360x165xH.180 mm Ice-cream basin 360x165xh.180 mm	DAVG18	HYDRA	-	48,80

**ACCESSORI**  
**ACCESSOIRES**  
**ZUBEHÖR**  
**ACCESSORIES**

LISTINO TARIF PREISLISTE PRICE LIST 2015	Descrizione Désignation Beschreibung Description	Modello Modèle Modell Model	Rif. apparecchiature Appareils de référence Gerätebezeichnung Appliance reference	GN	Prezzo € Prix € Preis € Price €
	Coperchio per bacinella gastronorm GN 1/1 Couvercle pour bac GN 1/1 Abdeckung für Behälter GN 1/1 Cover for GN container 1/1	DAC1	DABG120 - DABG110 - DAB1G12	-	36,70
	Coperchio per bacinella GN 1/4 Couvercle pour bac GN 1/4 Abdeckung für Behälter GN 1/4 Cover for GN container 1/4	DAC2	DABG1415	-	26,00
	Coperchio per vaschetta gelato GAVG18 Couvercle pour bac à glace GAVG18 Abdeckung für Eiscreme-Behälter GAVG18 Cover for Ice-cream basin GAVG18	DAC3	DAVG18	-	26,00
	Tendina termica GALAXY 14 Rideau thermique GALAXY 14 Nachttrollo GALAXY 14 Thermic front blind GALAXY 14	DATT14	GALAXY	-	255,00
	Tendina termica GALAXY 20 Rideau thermique GALAXY 20 Nachttrollo GALAXY 20 Thermic front blind GALAXY 20	DATT20	GALAXY	-	290,00
	Piano per vasca gelato HY3 Plateau pour cuve à glace HY3 Abstellboden für Eiscreme-Wanne HY3 Shelf for ice-cream well HY3	DAPGE3	HYDRA	-	120,00
	Kit 2 piani per vasca gelato HY5 Jeu 2 plateaux pour cuve à glace HY5 Abstellbodenpaar für Eiscreme-Wanne HY5 Pair of shelves for ice-cream well HY5	DAPGE5	HYDRA	-	160,00
	Kit 2 piani per vasca gelato HY7 Jeu 2 plateaux pour cuve à glace HY7 Abstellbodenpaar für Eiscreme-Wanne HY7 Pair of shelves for ice-cream well HY7	DAPGE7	HYDRA	-	180,00
	Coperchio isolato in acciaio inox per vasca gelato HY3 Couvercle isolé en acier inox pour cuve à glace HY3 Isolierte Edelstahl-Abdeckung für Eiscreme-Wanne HY3 Insulated cover in s/steel for ice-cream well HY3	DACIGE3	HYDRA	-	270,00
	Coperchio isolato in acciaio inox per vasca gelato HY5 Couvercle isolé en acier inox pour cuve à glace HY5 Isolierte Edelstahl-Abdeckung für Eiscreme-Wanne HY5 Insulated cover in s/steel for ice-cream well HY5	DACIGE5	HYDRA	-	380,00



**ACCESSORI  
ACCESSOIRES  
ZUBEHÖR  
ACCESSORIES**





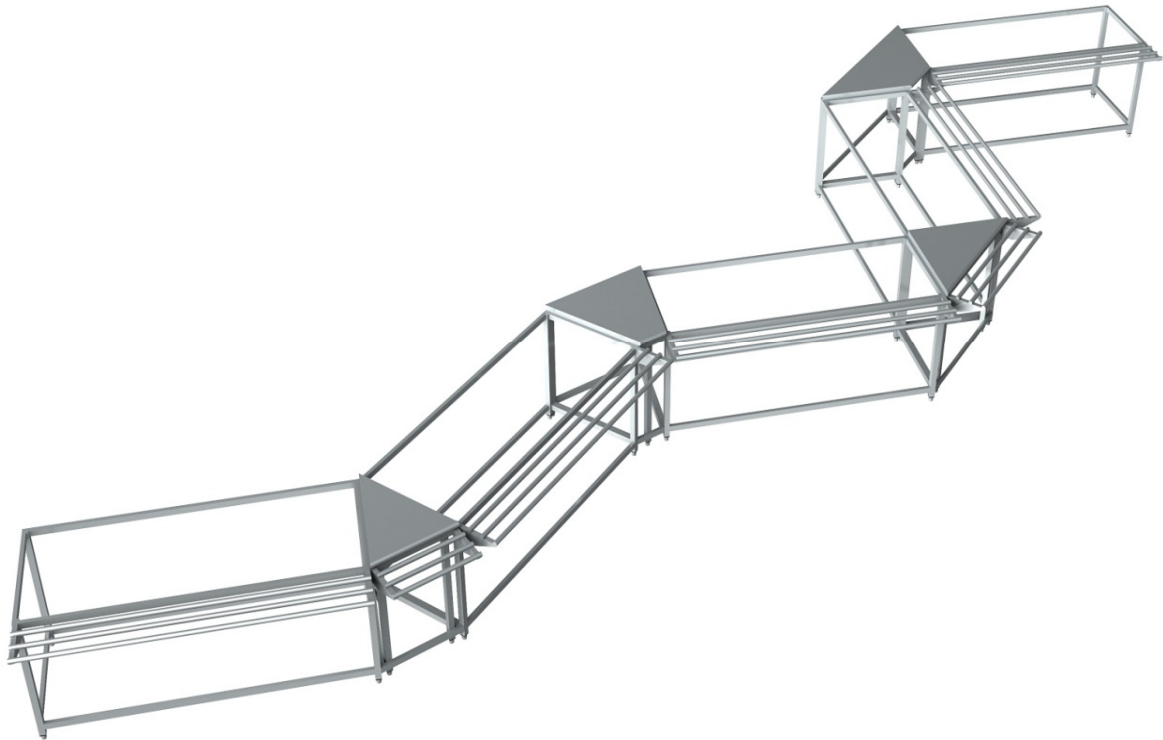



LISTINO TARIF PREISLISTE PRICE LIST 2015	Descrizione Désignation Beschreibung Description	Modello Modèle Modell Model	Rif. apparecchiature Appareils de référence Gerätebezugnahme Appliance reference	GN	Prezzo € Prix € Preis € Price €
	Coperchio isolato in acciaio inox per vasca gelato HY7 Couvercle isolé en acier inox pour cuve à glace HY7 Isolierte Edelstahl-Abdeckung für Eiscreme-Wanne HY7 Insulated cover in s/steel for ice-cream well HY7	DACIGE7	HYDRA	-	460,00
	Coperchio scorrevole per vasca gelato HY3 Couvercle coulissant pour cuve à glace HY3 Schiebeabdeckung für Eiscreme-Wanne HY3 Sliding cover for ice-cream well HY3	DACSGE3	HYDRA	-	230,00
	Coperchio scorrevole per vasca gelato HY5 Couvercle coulissant pour cuve à glace HY5 Schiebeabdeckung für Eiscreme-Wanne HY5 Sliding cover for ice-cream well HY5	DACSGE5	HYDRA	-	285,00
	Coperchio scorrevole per vasca gelato HY7 Couvercle coulissant pour cuve à glace HY7 Schiebeabdeckung für Eiscreme-Wanne HY7 Sliding cover for ice-cream well HY7	DACSGE7	HYDRA	-	330,00

**LISTINO STRUTTURE  
TARIF STRUCTURES  
ROHRGESTELLE-PREISELISTE  
FRAME PRICE LIST**











**DE** Modulare Rohrgestelle aus Edelstahl AISI 304 für die Aufnahme von Drop-in-Elementen, Show-Pasta, Aufsatzelementen, Wagen, Aufsatzkochgeräten usw. Sie können mit Paneelen aus Edelstahl AISI 304 wie nach Preisliste oder nach Belieben des Kunden mit anderen Materialien wie Holz, Granit usw. verkleidet werden.

**STRUTTURE  
STRUCTURES  
ROHRGESTELLE  
FRAMES**









LISTINO TARIF PREISLISTE PRICE LIST 2015	Descrizione Désignation Beschreibung Description	Modello Modèle Modell Model	Dimensioni Dimensions Abmessungen Dimensions	m <sup>3</sup> /kg	Prezzo € Prix € Preis € Price €
	Elemento cassa DX Élément caisse droit Kassenelement rechts Cashier element right	ECD	1560x780xh.860	1,5/	904,00
	Elemento cassa SX Élément caisse gauche Kassenelement links Cashier element left	ECS	1560x780xh.860	1,5/	904,00
	Elemento carrelli - Show Pasta Élément pour chariots-Show Pasta Einfahr-Element für Wagen und Show Pasta Show Pasta and trolley element	ECC1210 ECC1560 ECC1900	1210x780xh.860 1560x780xh.860 1900x780xh.860	1,2/ 1,5/ 1,8/	736,00 753,00 771,00
	Elemento top cottura Élément de support table de cuisson Tischkochgeräte-Element Cooktop element	ETC	1560x780xh.860	1,5/	858,00
	Elemento per piani - vasche - vetrine Élément de support plans-cuves-vitrines Trägerelement für Platten-Becken-Vitrinen Top-well-display support	EVV950 EVV1210 EVV1560 EVV1900 EVV2100	950x780xh.860 1210x780xh.860 1560x780xh.860 1900x780xh.860 2100x780xh.860	0,9/ 1,2/ 1,5/ 1,8/ 1,9/	771,00 801,00 840,00 888,00 900,00
	Elemento distribuzione vassoi-pane-coperti-bicchieri Élément distributeur plateaux-pain-couverts-verres Tablett-Brot-Besteck-Gläsern-Spenderelement Tray-bread-cutlery-glass dispenser element	EDVP	1210x780xh.270	0,5/	355,00
	Elemento angolo esterno 90° Élément angle ouvert 90° Außeneckelement 90° 90° external corner element	EAE90	780x780xh.760	0,7/	602,00
	Elemento angolo esterno 45° Élément angle ouvert 45° Außeneckelement 45° 45° external corner element	EAE45	780x780xh.760	0,7/	580,00

**STRUTTURE  
STRUCTURES  
ROHRGESTELLE  
FRAMES**









LISTINO TARIF PREISLISTE PRICE LIST 2015	Descrizione Description Beschreibung Description	Modello Modèle Modell Model	Dimensioni Dimensions Abmessungen Dimensions	m <sup>3</sup> /kg	Prezzo € Prix € Preis € Price €
	Elemento angolo interno 90° Élément angle fermé 90° Inneneckelement 90° 90° internal corner element	EAI90	780x780xh.760	0,7/	736,00
	Elemento angolo interno 45° Élément angle fermé 45° Inneneckelement 45° 45° internal corner element	EAI45	780x780xh.760	0,7/	667,00
	Scorriavassoio Rampe à plateaux Tablettrutsche Tray slide	ESV900 ESV1050 ESV1510 ESV1850 ESV2050	900x300 1050x300 1510x300 1850x300 2050x300	0,06/ 0,07/ 0,10/ 0,13/ 0,15/	380,00 402,00 460,00 540,00 555,00
	Scorriavassoio angolo esterno 45°-90° Rampe à plateaux angle ouvert 45-90° Tablettrutsche Außenecke 45°-90° 45°-90° external corner tray slide	ESVA600 ESVA1100	600x300 1100x300	0,05/ 0,08/	340,00 408,00
	Sovrastruttura distribuz. vassoi-pane-coperti-bicchieri Superstructure distribut. plateaux-pain-couverts-verres Aufbau Entnahme von Tablett-Brot-Besteck-Gläsern Tray-bread-cutlery-glass dispenser superstructure	ESD	610x650xh.950	0,6/	1.660,00
	Piano neutro * Plateau neutre * Neutralplatte * Neutral top *	EPN950 EPN1210 EPN1560 EPN1900 EPN2100	950x830xh.40 1210x830xh.40 1560x830xh.40 1900x830xh.40 2100x830xh.40	0,18/ 0,23/ 0,29/ 0,35/ 0,38/	560,00 662,00 792,00 827,00 983,00
	Piano inserimento carrelli - Show Pasta Plateau introduction chariots-Show Pasta Platte für Aufnahme von Wagen - Show-Pasta Top for trolley - Show insertion	EPC1210 EPC1560 EPC1900	1210/980x823xh.40 1680/1560x830xh.40 1900/1680x830xh.40	0,23/ 0,29/ 0,35/	857,00 888,00 918,00
	Piano per elemento cassa SX Plateau pour élément caisse gauche Platte für Kassenelement links Top for cashier element left	EPCSX	1560x830x40	0,27/	1.017,00

\* Prezzo per foro inserimento drop-in su richiesta / Sur demande prix pour découpe insertion des encastrables / Preis für Einbaugeräte-Öffnung auf Anfrage / Price for drop-in hole on request







**STRUTTURE  
STRUCTURES  
ROHRGESTELLE  
FRAMES**

LISTINO TARIF PREISLISTE PRICE LIST 2015	Descrizione Description Beschreibung Description	Modello Modèle Modell Model	Dimensioni Dimensions Abmessungen Dimensions	m <sup>3</sup> /kg	Prezzo € Prix € Preis € Price €
	Piano per elemento cassa DX Plateau pour élément caisse droit Platte für Kassenelement rechts Top for cashier element right	EPCDX	1560x830x40	0,27/	1.017,00
	Piano terminale SX Plateau d'extrémité gauche Endelement links End element left	EPTSX	830x40xh.440	0,076/	442,00
	Piano terminale DX Plateau d'extrémité droit Endelement rechts End element right	EPTDX	830x40xh.440	0,076/	442,00
	Piano supporto top cottura Plan de support table de cuisson Trägerplatte für Kochgeräte Cooktop support	EPSTC	1560/1480x830xh.40	0,3/	1.818,00
	Piano angolare esterno 90° Plateau angle ouvert 90° Außeneckplatte 90° 90° external corner worktop	EPAE90	830x830xh.40	0,16/	576,00
	Piano angolare esterno 45° Plateau angle ouvert 45° Außeneckplatte 45° 45° external corner worktop	EPAE45	830x830xh.40	0,16/	403,00
	Piano angolare interno 90° Plateau angle fermé 90° Inneneckplatte 90° 90° internal corner worktop	EPAI90	830x830xh.40	0,16/	684,00
	Piano angolare interno 45° Plateau angle fermé 45° Inneneckplatte 45° 45° internal corner worktop	EPAI45	830x830xh.40	0,16/	502,00

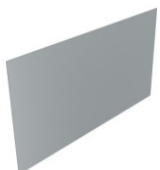







**STRUTTURE  
STRUCTURES  
ROHRGESTELLE  
FRAMES**

LISTINO TARIF PREISLISTE PRICE LIST 2015	Descrizione Description Beschreibung Description	Modello Modèle Modell Model	Dimensioni Dimensions Abmessungen Dimensions	m <sup>3</sup> /kg	Prezzo € Prix € Preis € Price €
	Pannello frontale esterno	EPFE950	950x760xh.15	0,14/	342,00
	Panneau frontal extérieur	EPFE1210	1210x760xh.15	0,33/	407,00
	Außenpaneel vorn	EPFE1560	1560x760xh.15	0,23/	502,00
	External front panel	EPFE1900	1900x760xh.15	0,28/	598,00
		EPFE2100	2100x760xh.15	0,31/	641,00
	Pannello laterale esterno Dx Panneau latéral extérieur droit Außenpaneel seitlich rechts External side panel right	EPLED	800x760xh.15	0,12/	295,00
	Pannello laterale esterno Sx Panneau latéral extérieur gauche Außenpaneel seitlich links External side panel left	EPLES	800x760xh.15	0,12/	295,00
	Pannello esterno frontale per angolo esterno 90° Panneau frontal extérieur pour angle ouvert 90° Außenpaneel vorn für Außenecke 90° External front panel for 90° external corner	EPEFAE90	1100x760xh.15	0,17/	377,00
	Pannello esterno frontale per angolo esterno 45° Panneau frontal extérieur pour angle ouvert 45° Außenpaneel vorn für Außenecke 45° External front panel for 45° external corner	EPEFAE45	600x760xh.15	0,1/	238,00
	Pannello esterno frontale per angolo interno 90° Panneau frontal extérieur pour angle fermé 90° Außenpaneel vorn für Innenecke 90° External front panel for 90° internal corner	EPEFAI90	450x760xh.15	0,14/	195,00
	Pannello esterno frontale per angolo interno 45° Panneau frontal extérieur pour angle fermé 45° Außenpaneel vorn für Innenecke 45° External front panel for 45° internal corner	EPEFAI45	250x760xh.15	0,08/	143,00
	Pannello frontale interno per struttura carrelli	EPFIC1130	1130x760	0,17/	381,00
	Panneau intérieur frontal pour structure chariots	EPFIC1480	1480x760	0,22/	498,00
	Innenpaneel vorn für Wagengestell Internal front panel for trolley frame	EPFIC1820	1820x760	0,27/	576,00

**STRUTTURE  
STRUCTURES  
ROHRGESTELLE  
FRAMES**







LISTINO TARIF PREISLISTE PRICE LIST 2015	Descrizione Description Beschreibung Description	Modello Modèle Modell Model	Dimensioni Dimensions Abmessungen Dimensions	m <sup>3</sup> /kg	Prezzo € Prix € Preis € Price €
	Pannello laterale interno Panneau latéral intérieur Innenpaneel seitlich Internal side panel	EPLI	710x760	0,11/	407,00
	Pannello frontale interno per elemento distribuzione Panneau frontal intérieur pour élément distributeur Innenpaneel vorn für Spenderelement Internal front panel for dispenser element	EPFID	1210x270	0,08/	187,00
	Pannello laterale interno per elemento distribuzione Panneau latéral intérieur pour élément distributeur Innenpaneel seitlich für Spenderelement Internal side panel for dispenser element	EPLID	800x270	0,04/	135,00
	Ripiano di fondo Étagère de fond Bodenplatte Bottom shelf	ERF950 ERF1210 ERF1560 ERF1900 ERF2100	950x790xh.50 1210x790xh.50 1560x790xh.50 1900x790xh.50 2100x790xh.50	0,18/ 0,23/ 0,29/ 0,35/ 0,38/	260,00 303,00 348,00 365,00 390,00
	Zoccolo laterale Plinthe latérale Fußleiste seitlich Side plinth	EZL	800x100	0,009/	96,00
	Zoccolo angolare esterno 90° Plinthe angle ouvert 90° Fußleiste Außenecke 90° 90° external corner plinth	EZAE90	1100x100	0,012/	99,00
	Zoccolo angolare esterno 45° Plinthe angle ouvert 45° Fußleiste Außenecke 45° 45° external corner plinth	EZAE45	600x100	0,007/	87,00
	Zoccolo angolare interno 90° Plinthe angle fermé 90° Fußleiste Innenecke 90° 90° internal corner plinth	EZAI90	450x100	0,005/	86,00

**STRUTTURE  
STRUCTURES  
ROHRGESTELLE  
FRAMES**



LISTINO TARIF PREISLISTE PRICE LIST 2015	Descrizione Description Beschreibung Description	Modello Modèle Modell Model	Dimensioni Dimensions Abmessungen Dimensions	m <sup>3</sup> /kg	Prezzo € Prix € Preis € Price €
	Zoccolo angolare interno 45° Plinthe angle fermé 45° Fußleiste Innenecke 45° 45° internal corner plinth	EZA145	250x100	0,003/	78,00
	Zoccolo frontale Plinthe frontale Fußleiste vorn Front plinth	EZF950 EZF1210 EZF1560 EZF1900 EZF2100	950x100 1210x100 1560x100 1900x100 2100x100	0,007/ 0,013/ 0,016/ 0,020/ 0,022/	95,00 104,00 112,00 121,00 126,00
	Kit 4 ruote per strutture Kit 4 roues pour structures Set mit 4 Rollen für Rohrgestelle Kit of 4 castors for frames	EKR	-	-	275,00
	Base di conservazione -14°÷-22°C 2 porte battenti Soubassement de conservation -14°÷-22°C 2 portes battantes Tiefkühlunterbau -14°÷-22°C mit 2 Flügeltüren Freezer cupboard -14°÷-22°C with 2 hinged doors	EBC12	1250x650xh.600	0,9/90	3.520,00
	Base refrigerata +2°÷+12°C con 2 porte battenti Soubassement réfrigéré +2°÷+12°C 2 portes battantes Kühlunterbau +2°÷+12°C mit 2 Flügeltüren Refrigerated cupboard +2°÷+12°C with 2 hinged doors	EBF12	1250x650xh.600	0,9/85	2.940,00
	Base di conservazione -14°÷-22°C 3 porte battenti Soubassement de conservation -14°÷-22°C 3 portes battantes Tiefkühlunterbau -14°÷-22°C mit 3 Flügeltüren Freezer cupboard -14°÷-22°C with 3 hinged doors	EBC16	1650x650xh.600	1,15/115	4.190,00
	Base refrigerata +2°÷+12°C con 3 porte battenti Soubassement réfrigéré +2°÷+12°C 3 portes battantes Kühlunterbau +2°÷+12°C mit 3 Flügeltüren Refrigerated cupboard +2°÷+12°C with 3 hinged doors	EBF16	1650x650xh.600	1,15/105	3.480,00
	Base calda Soubassement chauffant Warmunterbau Warming cupboard	EC12 EC16	1200x680xh.810 1600x680xh.810	0,9/ 1,2/	2.200,00 2.400,00









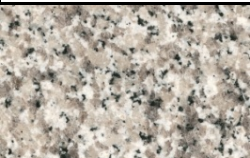

**STRUTTURE  
STRUCTURES  
ROHRGESTELLE  
FRAMES**

LISTINO TARIF PREISLISTE PRICE LIST 2015	Descrizione Description Beschreibung Description	Modello Modèle Modell Model	Dimensioni Dimensions Abmessungen Dimensions	m <sup>3</sup> /kg	Prezzo € Prix € Preis € Price €
	Elemento cassetto per cassa con serratura Élément tiroir caisse avec serrure Kassenschublade-Element mit Schloss Cashier drawer element with lock	ECC	380x430x h.170	0,047/	424,00
	Agganci sup./inf. pannello legno Attaches sup. et inf. pour panneau bois Holzpaneel-Befestigung unten/oben Wood panel fasteners up/down	EASIL	L.200	-	90,00
	Elemento per piani - vasche - vetrine Élément de support plans-cuves-vitrines Trägerelement für Platten-Becken-Vitrinen Top-well-display support	EVV950	ARIES - LIBRA - VIRGO - LYRA- GEMINI - VELA - HYDRA 2 GN		
	Elemento per piani - vasche - vetrine Élément de support plans-cuves-vitrines Trägerelement für Platten-Becken-Vitrinen Top-well-display support	EVV1210	ARIES - LIBRA - VIRGO - LYRA - GEMINI 3 GN VELA - PEGASUS - HYDRA 3 GN		
	Elemento per piani - vasche - vetrine Élément de support plans-cuves-vitrines Trägerelement für Platten-Becken-Vitrinen Top-well-display support	EVV1560	ARIES - LIBRA - VIRGO - LYRA - GEMINI 4 GN VELA - PEGASUS - HYDRA 4 GN		
	Elemento per piani - vasche - vetrine Élément de support plans-cuves-vitrines Trägerelement für Platten-Becken-Vitrinen Top-well-display support	EVV1900	ARIES - LIBRA - VIRGO - LYRA - GEMINI 5 GN VELA - PEGASUS 5 GN		
	Elemento per piani - vasche - vetrine Élément de support plans-cuves-vitrines Trägerelement für Platten-Becken-Vitrinen Top-well-display support	EVV2100	ARIES - LIBRA 6 GN		
	Elemento carrelli - Show Pasta Élément pour chariots-Show Pasta Einfahr-Element für Wagen und Show Pasta Show Pasta and trolley element	ECC1210	SHOW PASTA 1000		







**STRUTTURE  
STRUCTURES  
ROHRGESTELLE  
FRAMES**

	<p>Elemento carrelli - Show Pasta Élément pour chariots-Show Pasta Einfahr-Element für Wagen und Show Pasta Show Pasta and trolley element</p>	<p>ECC1560</p>	<p>SHOW PASTA 1300</p>
	<p>Elemento carrelli - Show Pasta Élément pour chariots-Show Pasta Einfahr-Element für Wagen und Show Pasta Show Pasta and trolley element</p>	<p>ECC1900</p>	<p>SHOW PASTA 1700</p>

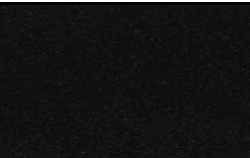

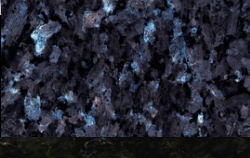

**GRANITI  
GRANITS  
GRANITE  
GRANITES**

	<b>Descrizione Description Beschreibung Description</b>	<b>Fascia di prezzo Tranche de prix Preisgruppe Price range</b>	<b>Materiale Matériau Material Material</b>	<b>Rif. apparecchiature Appareils de réf. Gerätebezugnahme Appliance reference</b>
	Bianco sardo	Fascia 1 Tranche de prix 1 Preisgruppe 1 Price range 1	Granito Granit Granit Granite	ARIES - LIBRA
	Rosa porrino	Fascia 1 Tranche de prix 1 Preisgruppe 1 Price range 1	Granito Granit Granit Granite	ARIES - LIBRA
	Rosa beta	Fascia 1 Tranche de prix 1 Preisgruppe 1 Price range 2	Granito Granit Granit Granite	ARIES - LIBRA
	Nero africa	Fascia 2 Tranche de prix 2 Preisgruppe 2 Price range 2	Granito Granit Granit Granite	ARIES - LIBRA
	Baltik Brown	Fascia 2 Tranche de prix 2 Preisgruppe 2 Price range 2	Granito Granit Granit Granite	ARIES - LIBRA
	Balmoral red	Fascia 2 Tranche de prix 2 Preisgruppe 2 Price range 2	Granito Granit Granit Granite	ARIES - LIBRA
	Bianco cristal	Fascia 2 Tranche de prix 2 Preisgruppe 2 Price range 2	Granito Granit Granit Granite	ARIES - LIBRA
	Juparana colombo	Fascia 2 Tranche de prix 2 Preisgruppe 2 Price range 2	Granito Granit Granit Granite	ARIES - LIBRA
	Kashemire white	Fascia 3 Tranche de prix 3 Preisgruppe 2 Price range 3	Granito Granit Granit Granite	ARIES - LIBRA
	Giallo veneziano	Fascia 3 Tranche de prix 3 Preisgruppe 2 Price range 3	Granito Granit Granit Granite	ARIES - LIBRA

**GRANITI  
GRANITS  
GRANITE  
GRANITES**

	Nero assoluto	Fascia 3 Tranche de prix 3 Preisgruppe 3 Price range 3	Granito Granit Granit Granite	ARIES - LIBRA
	Shivakasci	Fascia 3 Tranche de prix 3 Preisgruppe 3 Price range 3	Granito Granit Granit Granite	ARIES - LIBRA
	Verde marina	Fascia 3 Tranche de prix 3 Preisgruppe 3 Price range 3	Granito Granit Granit Granite	ARIES - LIBRA
	Verde eucalipto	Fascia 4 Tranche de prix 4 Preisgruppe 4 Price range 4	Granito Granit Granit Granite	ARIES - LIBRA
	New rubin	Fascia 4 Tranche de prix 4 Preisgruppe 4 Price range 4	Granito Granit Granit Granite	ARIES - LIBRA
	Maritaca	Fascia 4 Tranche de prix 4 Preisgruppe 4 Price range 4	Granito Granit Granit Granite	ARIES - LIBRA
	Bethel white	Fascia 5 Tranche de prix 5 Preisgruppe 5 Price range 5	Granito Granit Granit Granite	ARIES/LIBRA
	Pink salisbury	Fascia 5 Tranche de prix 5 Preisgruppe 5 Price range 5	Granito Granit Granit Granite	ARIES - LIBRA
	Kamelia White	Fascia 5 Tranche de prix 5 Preisgruppe 5 Price range 5	Granito Granit Granit Granite	ARIES - LIBRA
	Labrador blu	Fascia 5 Tranche de prix 5 Preisgruppe 5 Price range 5	Granito Granit Granit Granite	ARIES - LIBRA
	Labrador scuro	Fascia 5 Tranche de prix 5 Preisgruppe 5 Price range 5	Granito Granit Granit Granite	ARIES - LIBRA

**GRANITI  
GRANITS  
GRANITE  
GRANITES**

	<b>Descrizione Description Beschreibung Description</b>	<b>Fascia di prezzo Tranche de prix Preisgruppe Price range</b>	<b>Materiale Matériau Material Material</b>	<b>Rif. apparecchiature Appareils de réf. Gerätebezugsnahme Appliance reference</b>
	H1476 - Pino Avola Champagne	STANDARD	Laminato Stratifié Laminat Laminate	TAURUS
	H3058 - Wengé Mali	STANDARD	Laminato Stratifié Laminat Laminate	TAURUS
	H3090 – Driftwood	STANDARD	Laminato Stratifié Laminat Laminate	TAURUS
	H3304 - Rovere Chateau Grigio Velato	STANDARD	Laminato Stratifié Laminat Laminate	TAURUS
	H3331 - Rovere Nebraska mat	STANDARD	Laminato Stratifié Laminat Laminate	TAURUS